

LACASSE QUICKSHIP PROGRAM

> CONCEPT 300

LACASSE QUICKSHIP PROGRAM*

Products and suggested layouts identified by this pictogram are part of the Lacasse quick delivery program.

* Due to current market conditions, always refer to our Lead-Time Guide for a confirmation of our current Lacasse QuickShip lead-times.



PROGRAM CONDITIONS AND LIMITATIONS:

- Maximum of 35 of each selected item and of each color per order.
- QuickShip products are ready for shipment **after reception of a ready-to-process order and delivered on next available trailer.**

IMPORTANT:

Place QuickShip orders separately from regular Lacasse orders.

When preparing QuickShip orders, indicate the code "QS" in front of the product code or the suggested layout code, i.e.: QS31NE-F3672F.

AVAILABLE OPTIONS AND FINISHES:

Make sure to complete QuickShip product codes with the options and finish codes that are part of the QuickShip program. See below for the complete list of QuickShip options and finishes relevant to the Concept 300 collection:

- **HANDLES**
E, F



Please refer to the current LACASSE General Price Book to see all the collections and the details of the product offering.

CONCEPT 300 - QUICKSHIP PROGRAM

N EDGEBANDING

Furniture with 1" (25 mm) thick tops.



N Edge

Smooth, 1/16" (1,5 mm) thick edge. The N edge is matched with the finish specified for the surface.

HANDLES

Choice of metal handles available.



E - Square, silver



F - Round, silver

LEG V

In metal.



V - Round, silver

CODIFICATION

Series	Options		
	Thickness	Edgebanding	Handles
QS3	1 Thermofused laminate 1"	N Smooth edge	E Square, silver F Round, silver N N/A

	W x D x H (in)	W x D x H (mm)	Code	Price (\$)
--	----------------	----------------	------	------------

DESKS

Double pedestal desks

2 pedestals with locks. 2 box drawers and 2 file drawers with suspension bars. Pencil tray. Recessed 3/4 height modesty panel.

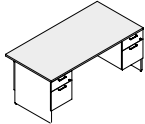

72 x 36 x 29	1800 x 900 x 735	QS31N_-F3672F	1,918
72 x 30 x 29	1800 x 750 x 735	QS31N_-F3072F	1,854
66 x 30 x 29	1650 x 750 x 735	QS31N_-F3066F	1,772
60 x 30 x 29	1500 x 750 x 735	QS31N_-F3060F	1,709

Specify the handle code (E, F).

Double pedestal desks - inner drawers

2 pedestals with locks. Pedestals with full-height fronts concealing 2 box drawers and 2 file drawers with suspension bars. Pencil tray. Recessed 3/4 height modesty panel.

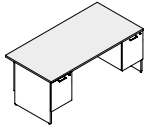

72 x 36 x 29	1800 x 900 x 735	QS31N_-IF3672IF	1,749
72 x 30 x 29	1800 x 750 x 735	QS31N_-IF3072IF	1,684
66 x 30 x 29	1650 x 750 x 735	QS31N_-IF3066IF	1,612
60 x 30 x 29	1500 x 750 x 735	QS31N_-IF3060IF	1,538

Specify the handle code (E, F).

Double pedestal desks - low profile

2 pedestals with locks. 2 box drawers and 3 file drawers with suspension bars. Pencil tray. Recessed, full-height modesty panel.

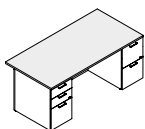

72 x 36 x 29	1800 x 900 x 735	QS31N_-UF3672FF	2,376
72 x 30 x 29	1800 x 750 x 735	QS31N_-UF3072FF	2,296
66 x 30 x 29	1650 x 750 x 735	QS31N_-UF3066FF	2,231
60 x 30 x 29	1500 x 750 x 735	QS31N_-UF3060FF	2,167

Specify the handle code (E, F).

Left single pedestal desks

1 pedestal on left with lock. 1 box drawer and 1 file drawer with suspension bar. Pencil tray. Recessed 3/4 height modesty panel.

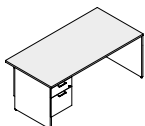

72 x 36 x 29	1800 x 900 x 735	QS31N_-F3672S	1,445
72 x 30 x 29	1800 x 750 x 735	QS31N_-F3072S	1,364
66 x 30 x 29	1650 x 750 x 735	QS31N_-F3066S	1,298
60 x 30 x 29	1500 x 750 x 735	QS31N_-F3060S	1,232
48 x 30 x 29	1200 x 750 x 735	QS31N_-F3048S	1,144

Specify the handle code (E, F).

Right single pedestal desks

1 pedestal on right with lock. 1 box drawer and 1 file drawer with suspension bar. Pencil tray. Recessed 3/4 height modesty panel.

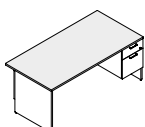

72 x 36 x 29	1800 x 900 x 735	QS31N_-S3672F	1,445
72 x 30 x 29	1800 x 750 x 735	QS31N_-S3072F	1,364
66 x 30 x 29	1650 x 750 x 735	QS31N_-S3066F	1,298
60 x 30 x 29	1500 x 750 x 735	QS31N_-S3060F	1,232
48 x 30 x 29	1200 x 750 x 735	QS31N_-S3048F	1,144

Specify the handle code (E, F).

	W x D x H (in)	W x D x H (mm)	Code	Price (\$)
--	----------------	----------------	------	------------

Left single pedestal desks - inner drawers

1 pedestal on left with lock. Pedestal with full-height front concealing 1 box drawer and 1 file drawer with suspension bar. Pencil tray. Recessed 3/4 height modesty panel.

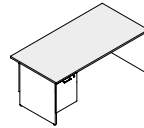

72 x 36 x 29	1800 x 900 x 735	QS31N_-IF3672S	1,282
72 x 30 x 29	1800 x 750 x 735	QS31N_-IF3072S	1,211
66 x 30 x 29	1650 x 750 x 735	QS31N_-IF3066S	1,152
60 x 30 x 29	1500 x 750 x 735	QS31N_-IF3060S	1,088
48 x 30 x 29	1200 x 750 x 735	QS31N_-IF3048S	998

Specify the handle code (E, F).

Right single pedestal desks - inner drawers

1 pedestal on right with lock. Pedestal with full-height front concealing 1 box drawer and 1 file drawer with suspension bar. Pencil tray. Recessed 3/4 height modesty panel.

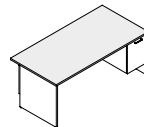

72 x 36 x 29	1800 x 900 x 735	QS31N_-S3672IF	1,282
72 x 30 x 29	1800 x 750 x 735	QS31N_-S3072IF	1,211
66 x 30 x 29	1650 x 750 x 735	QS31N_-S3066IF	1,152
60 x 30 x 29	1500 x 750 x 735	QS31N_-S3060IF	1,088
48 x 30 x 29	1200 x 750 x 735	QS31N_-S3048IF	998

Specify the handle code (E, F).

Left single pedestal desks - low profile

1 pedestal on left with lock. 2 box drawers and 1 file drawer with suspension bar. Pencil tray. Recessed, full-height modesty panel.

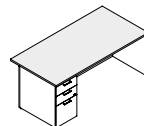

72 x 36 x 29	1800 x 900 x 735	QS31N_-UF3672S	1,702
72 x 30 x 29	1800 x 750 x 735	QS31N_-UF3072S	1,635
66 x 30 x 29	1650 x 750 x 735	QS31N_-UF3066S	1,564
60 x 30 x 29	1500 x 750 x 735	QS31N_-UF3060S	1,490
48 x 30 x 29	1200 x 750 x 735	QS31N_-UF3048S	1,384

Specify the handle code (E, F).

Right single pedestal desks - low profile

1 pedestal on right with lock. 2 box drawers and 1 file drawer with suspension bar. Pencil tray. Recessed, full-height modesty panel.

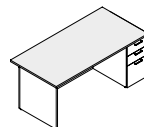

72 x 36 x 29	1800 x 900 x 735	QS31N_-S3672UF	1,702
72 x 30 x 29	1800 x 750 x 735	QS31N_-S3072UF	1,635
66 x 30 x 29	1650 x 750 x 735	QS31N_-S3066UF	1,564
60 x 30 x 29	1500 x 750 x 735	QS31N_-S3060UF	1,490
48 x 30 x 29	1200 x 750 x 735	QS31N_-S3048UF	1,384

Specify the handle code (E, F).

Desk shells

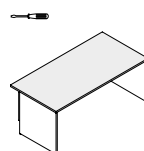

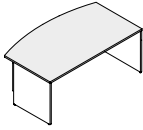

Recessed 3/4 height modesty panel. Can accommodate 1 or 2 pedestals.

72 x 36 x 29	1800 x 900 x 735	QS31NN-S3672S	1,054
72 x 30 x 29	1800 x 750 x 735	QS31NN-S3072S	1,015
66 x 30 x 29	1650 x 750 x 735	QS31NN-S3066S	984
60 x 30 x 29	1500 x 750 x 735	QS31NN-S3060S	935
48 x 30 x 29	1200 x 750 x 735	QS31NN-S3048S	862

	W x D x H (in)	W x D x H (mm)	Code	Price (\$)
Bow front desk shells	<i>Recessed 3/4 height modesty panel. Can accommodate 1 or 2 pedestals.</i>			
	72 x 36 x 29	1800 x 900 x 735	QS31NN-S3672SA	1,211
	72 x 30 x 29	1800 x 750 x 735	QS31NN-S3072SA	1,169
	66 x 30 x 29	1650 x 750 x 735	QS31NN-S3066SA	1,138
	60 x 30 x 29	1500 x 750 x 735	QS31NN-S3060SA	1,080
	48 x 30 x 29	1200 x 750 x 735	QS31NN-S3048SA	984

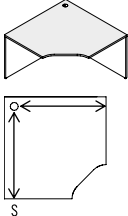
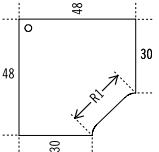
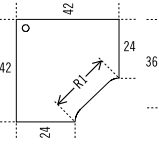
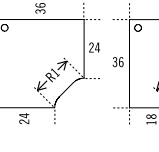
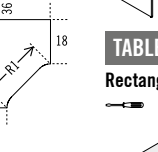
CORNER MODULES

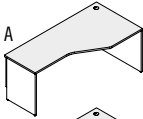
Corner modules	<i>Full-height modesty panel. 1 grommet. Must be attached to another surface.</i>			
				
	Surface 48"/30" R1 25" (635 mm)	42"/24" 25" (635 mm)	36"/24" 16 7/8" (424 mm)	36"/18" 25" (635 mm)
	48 x 48 x 29	1200 x 1200 x 735	QS31NN-CM4830S	1,119
	42 x 42 x 29	1050 x 1050 x 735	QS31NN-CM4224S	984
	36 x 36 x 29	900 x 900 x 735	QS31NN-CM3624S	896
	36 x 36 x 29	900 x 900 x 735	QS31NN-CM3618S	896

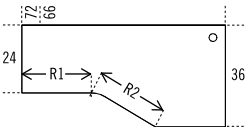
Left extended corner modules – 24" D	<i>Recessed 3/4 height modesty panel on extended side. 1 grommet.</i>			
			Surface 72"/36" R1 23 3/4" (591 mm) 66"/36" 17 3/8" (441 mm)	R2 25 3/4" (655 mm) 25 3/4" (655 mm)
		72 x 36 x 29	1800 x 900 x 735	QS31NN-CM723624_ 1,169
		66 x 36 x 29	1650 x 900 x 735	QS31NN-CM663624_ 1,096
Specify panel legs (A, B).				

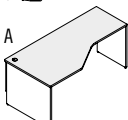
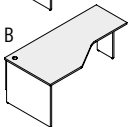
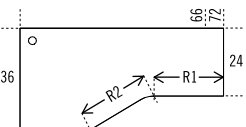
Right extended corner modules – 24" D	<i>Recessed 3/4 height modesty panel on extended side. 1 grommet.</i>			
			Surface 72"/36" R1 23 3/4" (591 mm) 66"/36" 17 3/8" (441 mm)	R2 25 3/4" (655 mm) 25 3/4" (655 mm)
		72 x 36 x 29	1800 x 900 x 735	QS31NN-CM367224_ 1,169
		66 x 36 x 29	1650 x 900 x 735	QS31NN-CM366624_ 1,096
Specify panel legs (A, B).				

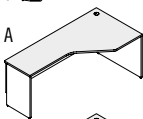
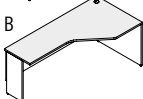
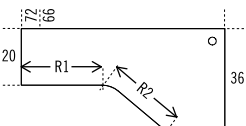
Left extended corner modules – 20" D	<i>Recessed 3/4 height modesty panel on extended side. 1 grommet.</i>			
			Surface 72"/36" R1 27" (687 mm) 66"/36" 21" (536 mm)	R2 27 1/8" (709 mm) 27 1/8" (709 mm)
		72 x 36 x 29	1800 x 900 x 735	QS31NN-CM723620_ 1,169
		66 x 36 x 29	1650 x 900 x 735	QS31NN-CM663620_ 1,096
Specify panel legs (A, B).				

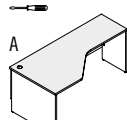
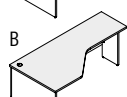
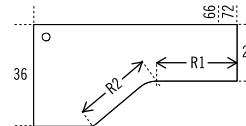
Right extended corner modules – 20" D	<i>Recessed 3/4 height modesty panel on extended side. 1 grommet.</i>				
			Surface 72"/36" 66"/36"	R1 27" (687 mm) 21" (536 mm)	R2 27 1/8" (709 mm) 27 1/8" (709 mm)
		72 x 36 x 29	1800 x 900 x 735	QS31NN-CM367220_ 1,169	
		66 x 36 x 29	1650 x 900 x 735	QS31NN-CM366620_ 1,096	
Specify panel legs (A, B).					

TABLES

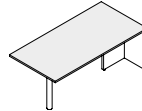
Rectangular tables	<i>Steel leg, silver. Must be attached to another work surface.</i>			
	72 x 36 x 29	1800 x 900 x 735	QS31NN-RT3672	870
	72 x 30 x 29	1800 x 750 x 735	QS31NN-RT3072	823
	66 x 30 x 29	1650 x 750 x 735	QS31NN-RT3066	779
	60 x 30 x 29	1500 x 750 x 735	QS31NN-RT3060	752
	66 x 24 x 29	1650 x 600 x 735	QS31NN-RT2466	718
	60 x 24 x 29	1500 x 600 x 735	QS31NN-RT2460	686
	48 x 24 x 29	1200 x 600 x 735	QS31NN-RT2448	645

Rectangular tables with laminate modesty panel	<i>Reversible. Half-height laminate modesty panel. Steel leg, silver. Must be attached to another work surface.</i>			
	72 x 36 x 29	1800 x 900 x 735	QS31NN-RTM3672	998
	72 x 30 x 29	1800 x 750 x 735	QS31NN-RTM3072	951
	66 x 30 x 29	1650 x 750 x 735	QS31NN-RTM3066	918
	60 x 30 x 29	1500 x 750 x 735	QS31NN-RTM3060	885

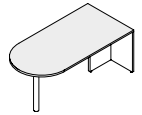
D-shaped tables	<i>Steel leg, silver. Must be attached to another work surface.</i>			
	72 x 36 x 29	1800 x 900 x 735	QS31NN-BT3672	1,008
	72 x 30 x 29	1800 x 750 x 735	QS31NN-BT3072	942
	66 x 30 x 29	1650 x 750 x 735	QS31NN-BT3066	896
	60 x 30 x 29	1500 x 750 x 735	QS31NN-BT3060	847
	66 x 24 x 29	1650 x 600 x 735	QS31NN-BT2466	779
	60 x 24 x 29	1500 x 600 x 735	QS31NN-BT2460	742
	48 x 24 x 29	1200 x 600 x 735	QS31NN-BT2448	701

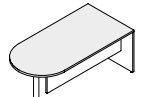
D-shaped tables	<i>Steel leg, silver. Must be attached to another work surface.</i>			
	72 x 36 x 29	1800 x 900 x 735	QS31NN-BTM3672	1,144
	72 x 30 x 29	1800 x 750 x 735	QS31NN-BTM3072	1,080
	66 x 30 x 29	1650 x 750 x 735	QS31NN-BTM3066	1,021
	60 x 30 x 29	1500 x 750 x 735	QS31NN-BTM3060	973

 = ASSEMBLY REQUIRED

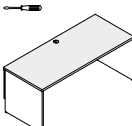
	W x D x H (in)	W x D x H (mm)	Code	Price (\$)
Rectangular tables – 30" D	<i>¾ height modesty panel. 1 grommet. Can accommodate 1 or 2 pedestals.</i>			
	A	BL	BR	C
	72 x 30 x 29	1800 x 750 x 735	QS31NN-DT3072_	918
	66 x 30 x 29	1650 x 750 x 735	QS31NN-DT3066_	870
	60 x 30 x 29	1500 x 750 x 735	QS31NN-DT3060_	823
	54 x 30 x 29	1350 x 750 x 735	QS31NN-DT3054_	773
	48 x 30 x 29	1200 x 750 x 735	QS31NN-DT3048_	731
	42 x 30 x 29	1050 x 750 x 735	QS31NN-DT3042_	701
	36 x 30 x 29	900 x 750 x 735	QS31NN-DT3036_	661
	30 x 30 x 29	750 x 750 x 735	QS31NN-DT3030_	620
	24 x 30 x 29	600 x 750 x 735	QS31NN-DT3024_	590
	Specify panel legs (A, BL, BR, C).			

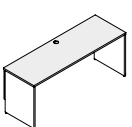
	W x D x H (in)	W x D x H (mm)	Code	Price (\$)
Rectangular tables – 24" D	<i>¾ height modesty panel. 1 grommet. Can accommodate 1 or 2 pedestals.</i>			
	A	BL	BR	C
	72 x 24 x 29	1800 x 600 x 735	QS31NN-DT2472_	885
	66 x 24 x 29	1650 x 600 x 735	QS31NN-DT2466_	831
	60 x 24 x 29	1500 x 600 x 735	QS31NN-DT2460_	779
	54 x 24 x 29	1350 x 600 x 735	QS31NN-DT2454_	742
	48 x 24 x 29	1200 x 600 x 735	QS31NN-DT2448_	701
	42 x 24 x 29	1050 x 600 x 735	QS31NN-DT2442_	661
	36 x 24 x 29	900 x 600 x 735	QS31NN-DT2436_	620
	30 x 24 x 29	750 x 600 x 735	QS31NN-DT2430_	590
	24 x 24 x 29	600 x 600 x 735	QS31NN-DT2424_	556
	Specify panel legs (A, BL, BR, C).			

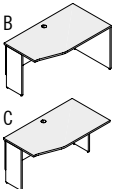
	W x D x H (in)	W x D x H (mm)	Code	Price (\$)												
Left asymmetrical tables – 30" D	<i>Recessed ¾ height modesty panel. 1 grommet. 42" to 54" (1050 to 1350 mm) tables can accommodate 1 pedestal.</i>															
	<table border="1"> <thead> <tr> <th>Surface</th> <th>R1</th> </tr> </thead> <tbody> <tr> <td>54"/30"</td> <td>33" (836 mm)</td> </tr> <tr> <td>48"/30"</td> <td>27" (686 mm)</td> </tr> <tr> <td>42"/30"</td> <td>21½" (536 mm)</td> </tr> <tr> <td>36"/30"</td> <td>15½" (386 mm)</td> </tr> <tr> <td>30"/30"</td> <td>9¼" (236 mm)</td> </tr> </tbody> </table>				Surface	R1	54"/30"	33" (836 mm)	48"/30"	27" (686 mm)	42"/30"	21½" (536 mm)	36"/30"	15½" (386 mm)	30"/30"	9¼" (236 mm)
Surface	R1															
54"/30"	33" (836 mm)															
48"/30"	27" (686 mm)															
42"/30"	21½" (536 mm)															
36"/30"	15½" (386 mm)															
30"/30"	9¼" (236 mm)															
	54 x 30 x 29	1350 x 750 x 735	QS31NN-AT245430_	847												
	48 x 30 x 29	1200 x 750 x 735	QS31NN-AT244830_	798												
	42 x 30 x 29	1050 x 750 x 735	QS31NN-AT244230_	766												
	36 x 30 x 29	900 x 750 x 735	QS31NN-AT243630_	731												
	30 x 30 x 29	750 x 750 x 735	QS31NN-AT243030_	701												
	Specify panel legs (B, C).															

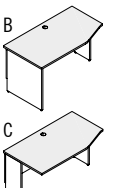
	W x D x H (in)	W x D x H (mm)	Code	Price (\$)												
Right asymmetrical tables – 30" D	<i>Recessed ¾ height modesty panel. 1 grommet. 42" to 54" (1050 to 1350 mm) tables can accommodate 1 pedestal.</i>															
	<table border="1"> <thead> <tr> <th>Surface</th> <th>R1</th> </tr> </thead> <tbody> <tr> <td>54"/30"</td> <td>33" (836 mm)</td> </tr> <tr> <td>48"/30"</td> <td>27" (686 mm)</td> </tr> <tr> <td>42"/30"</td> <td>21½" (536 mm)</td> </tr> <tr> <td>36"/30"</td> <td>15½" (386 mm)</td> </tr> <tr> <td>30"/30"</td> <td>9¼" (236 mm)</td> </tr> </tbody> </table>				Surface	R1	54"/30"	33" (836 mm)	48"/30"	27" (686 mm)	42"/30"	21½" (536 mm)	36"/30"	15½" (386 mm)	30"/30"	9¼" (236 mm)
Surface	R1															
54"/30"	33" (836 mm)															
48"/30"	27" (686 mm)															
42"/30"	21½" (536 mm)															
36"/30"	15½" (386 mm)															
30"/30"	9¼" (236 mm)															
	54 x 30 x 29	1350 x 750 x 735	QS31NN-AT305424_	847												
	48 x 30 x 29	1200 x 750 x 735	QS31NN-AT304824_	798												
	42 x 30 x 29	1050 x 750 x 735	QS31NN-AT304224_	766												
	36 x 30 x 29	900 x 750 x 735	QS31NN-AT303624_	731												
	30 x 30 x 29	750 x 750 x 735	QS31NN-AT303024_	701												
	Specify panel legs (B, C).															

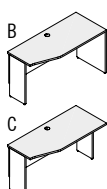
	W x D x H (in)	W x D x H (mm)	Code	Price (\$)												
Left asymmetrical tables – 24" D	<i>Recessed ¾ height modesty panel. 1 grommet. 42" to 54" (1050 to 1350 mm) tables can accommodate 1 pedestal.</i>															
	<table border="1"> <thead> <tr> <th>Surface</th> <th>R1</th> </tr> </thead> <tbody> <tr> <td>54"/24"</td> <td>33" (836 mm)</td> </tr> <tr> <td>48"/24"</td> <td>27" (686 mm)</td> </tr> <tr> <td>42"/24"</td> <td>21½" (536 mm)</td> </tr> <tr> <td>36"/24"</td> <td>15½" (386 mm)</td> </tr> <tr> <td>30"/24"</td> <td>9¼" (236 mm)</td> </tr> </tbody> </table>				Surface	R1	54"/24"	33" (836 mm)	48"/24"	27" (686 mm)	42"/24"	21½" (536 mm)	36"/24"	15½" (386 mm)	30"/24"	9¼" (236 mm)
Surface	R1															
54"/24"	33" (836 mm)															
48"/24"	27" (686 mm)															
42"/24"	21½" (536 mm)															
36"/24"	15½" (386 mm)															
30"/24"	9¼" (236 mm)															
	54 x 24 x 29	1350 x 600 x 735	QS31NN-AT185424_	798												
	48 x 24 x 29	1200 x 600 x 735	QS31NN-AT184824_	766												
	42 x 24 x 29	1050 x 600 x 735	QS31NN-AT184224_	731												
	36 x 24 x 29	900 x 600 x 735	QS31NN-AT183624_	701												
	30 x 24 x 29	750 x 600 x 735	QS31NN-AT183024_	661												
	Specify panel legs (B, C).															

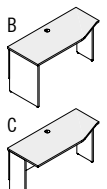
	W x D x H (in)	W x D x H (mm)	Code	Price (\$)												
Right asymmetrical tables – 24" D	<i>Recessed ¾ height modesty panel. 1 grommet. 42" to 54" (1050 to 1350 mm) tables can accommodate 1 pedestal.</i>															
	<table border="1"> <thead> <tr> <th>Surface</th> <th>R1</th> </tr> </thead> <tbody> <tr> <td>54"/24"</td> <td>33" (836 mm)</td> </tr> <tr> <td>48"/24"</td> <td>27" (686 mm)</td> </tr> <tr> <td>42"/24"</td> <td>21½" (536 mm)</td> </tr> <tr> <td>36"/24"</td> <td>15½" (386 mm)</td> </tr> <tr> <td>30"/24"</td> <td>9¼" (236 mm)</td> </tr> </tbody> </table>				Surface	R1	54"/24"	33" (836 mm)	48"/24"	27" (686 mm)	42"/24"	21½" (536 mm)	36"/24"	15½" (386 mm)	30"/24"	9¼" (236 mm)
Surface	R1															
54"/24"	33" (836 mm)															
48"/24"	27" (686 mm)															
42"/24"	21½" (536 mm)															
36"/24"	15½" (386 mm)															
30"/24"	9¼" (236 mm)															
	54 x 24 x 29	1350 x 600 x 735	QS31NN-AT245418_	798												
	48 x 24 x 29	1200 x 600 x 735	QS31NN-AT244818_	766												
	42 x 24 x 29	1050 x 600 x 735	QS31NN-AT244218_	731												
	36 x 24 x 29	900 x 600 x 735	QS31NN-AT243618_	701												
	30 x 24 x 29	750 x 600 x 735	QS31NN-AT243018_	661												
	Specify panel legs (B, C).															

	W x D x H (in)	W x D x H (mm)	Code	Price (\$)
Additional full-width legs	<i>1 tone only. L at the end of the code: left leg; R at the end of the code: right leg.</i>			
	30 x 1 x 27½	706 x 25 x 698	QS3NNN-L30L	217
	30 x 1 x 27½	706 x 25 x 698	QS3NNN-L30R	217
	24 x 1 x 27½	556 x 25 x 698	QS3NNN-L24L	203
	24 x 1 x 27½	556 x 25 x 698	QS3NNN-L24R	203
	20 x 1 x 27½	456 x 25 x 698	QS3NNN-L20L	185
	20 x 1 x 27½	456 x 25 x 698	QS3NNN-L20R	185

	W x D x H (in)	W x D x H (mm)	Code	Price (\$)
Additional recessed legs	<i>1 tone only. L at the end of the code: left leg; R at the end of the code: right leg.</i>			
	12 x 1 x 27½	300 x 25 x 698	QS3NNN-L12L	168
	12 x 1 x 27½	300 x 25 x 698	QS3NNN-L12R	168

CREDENZAS

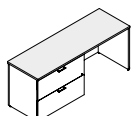
	W x D x H (in)	W x D x H (mm)	Code	Price (\$)
Left lateral file credenzas	<i>2 file drawers on left with suspension bars. Lock. Recessed, full-height modesty panel.</i>			
	72 x 24 x 29	1800 x 600 x 735	QS31N_-LF2472S	1,786
	66 x 24 x 29	1650 x 600 x 735	QS31N_-LF2466S	1,690
	60 x 24 x 29	1500 x 600 x 735	QS31N_-LF2460S	1,621
	72 x 20 x 29	1800 x 500 x 735	QS31N_-LF2072S	1,660
	66 x 20 x 29	1650 x 500 x 735	QS31N_-LF2066S	1,578
	60 x 20 x 29	1500 x 500 x 735	QS31N_-LF2060S	1,499
	Specify the handle code (E, F).			

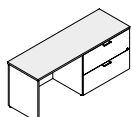
	W x D x H (in)	W x D x H (mm)	Code	Price (\$)
Right lateral file credenzas	<i>2 file drawers on right with suspension bars. Lock. Recessed, full-height modesty panel.</i>			
	72 x 24 x 29	1800 x 600 x 735	QS31N_-S2472LF	1,786
	66 x 24 x 29	1650 x 600 x 735	QS31N_-S2466LF	1,690
	60 x 24 x 29	1500 x 600 x 735	QS31N_-S2460LF	1,621
	72 x 20 x 29	1800 x 500 x 735	QS31N_-S2072LF	1,660
	66 x 20 x 29	1650 x 500 x 735	QS31N_-S2066LF	1,578
	60 x 20 x 29	1500 x 500 x 735	QS31N_-S2060LF	1,499
	Specify the handle code (E, F).			

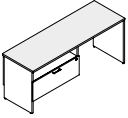
	W x D x H (in)	W x D x H (mm)	Code	Price (\$)
Left lateral file credenzas with open storage 	<i>Open space and 1 file drawer with suspension bar on left. Lock. Recessed 3/4 height modesty panel.</i>			
	72 x 24 x 29	1800 x 600 x 735	QS31N_-SLF2472S	1,490
	66 x 24 x 29	1650 x 600 x 735	QS31N_-SLF2466S	1,434
	60 x 24 x 29	1500 x 600 x 735	QS31N_-SLF2460S	1,364
	72 x 20 x 29	1800 x 500 x 735	QS31N_-SLF2072S	1,395
	66 x 20 x 29	1650 x 500 x 735	QS31N_-SLF2066S	1,364
60 x 20 x 29	1500 x 500 x 735	QS31N_-SLF2060S	1,329	
Specify the handle code (E, F).				

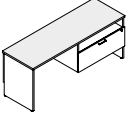
	W x D x H (in)	W x D x H (mm)	Code	Price (\$)
Right lateral file credenzas with open storage 	<i>Open space and 1 file drawer with suspension bar on right. Lock. Recessed 3/4 height modesty panel.</i>			
	72 x 24 x 29	1800 x 600 x 735	QS31N_-S2472SLF	1,490
	66 x 24 x 29	1650 x 600 x 735	QS31N_-S2466SLF	1,434
	60 x 24 x 29	1500 x 600 x 735	QS31N_-S2460SLF	1,364
	72 x 20 x 29	1800 x 500 x 735	QS31N_-S2072SLF	1,395
	66 x 20 x 29	1650 x 500 x 735	QS31N_-S2066SLF	1,364
60 x 20 x 29	1500 x 500 x 735	QS31N_-S2060SLF	1,329	
Specify the handle code (E, F).				

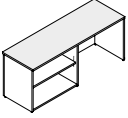
	W x D x H (in)	W x D x H (mm)	Code	Price (\$)
Left open bookcase credenzas 	<i>Adjustable shelf. Recessed, full-height modesty panel.</i>			
	72 x 24 x 29	1800 x 600 x 735	QS31NN-BE2472S	1,475
	66 x 24 x 29	1650 x 600 x 735	QS31NN-BE2466S	1,445
	60 x 24 x 29	1500 x 600 x 735	QS31NN-BE2460S	1,411
	72 x 20 x 29	1800 x 500 x 735	QS31NN-BE2072S	1,384
	66 x 20 x 29	1650 x 500 x 735	QS31NN-BE2066S	1,355
60 x 20 x 29	1500 x 500 x 735	QS31NN-BE2060S	1,322	

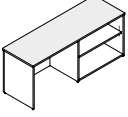
	W x D x H (in)	W x D x H (mm)	Code	Price (\$)
Right open bookcase credenzas 	<i>Adjustable shelf. Recessed, full-height modesty panel.</i>			
	72 x 24 x 29	1800 x 600 x 735	QS31NN-S2472BE	1,475
	66 x 24 x 29	1650 x 600 x 735	QS31NN-S2466BE	1,445
	60 x 24 x 29	1500 x 600 x 735	QS31NN-S2460BE	1,411
	72 x 20 x 29	1800 x 500 x 735	QS31NN-S2072BE	1,384
	66 x 20 x 29	1650 x 500 x 735	QS31NN-S2066BE	1,355
60 x 20 x 29	1500 x 500 x 735	QS31NN-S2060BE	1,322	

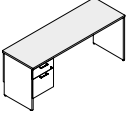
	W x D x H (in)	W x D x H (mm)	Code	Price (\$)
Left pedestal credenzas 	<i>1 pedestal on left with lock. 1 box drawer and 1 file drawer with suspension bar. Pencil tray. Recessed 3/4 height modesty panel.</i>			
	72 x 24 x 29	1800 x 600 x 735	QS31N_-F2472S	1,274
	66 x 24 x 29	1650 x 600 x 735	QS31N_-F2466S	1,242
	60 x 24 x 29	1500 x 600 x 735	QS31N_-F2460S	1,211
	72 x 20 x 29	1800 x 500 x 735	QS31N_-F2072S	1,232
	66 x 20 x 29	1650 x 500 x 735	QS31N_-F2066S	1,201
60 x 20 x 29	1500 x 500 x 735	QS31N_-F2060S	1,176	
Specify the handle code (E, F).				

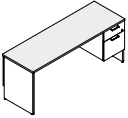
	W x D x H (in)	W x D x H (mm)	Code	Price (\$)
Right pedestal credenzas 	<i>1 pedestal on right with lock. 1 box drawer and 1 file drawer with suspension bar. Pencil tray. Recessed 3/4 height modesty panel.</i>			
	72 x 24 x 29	1800 x 600 x 735	QS31N_-S2472F	1,274
	66 x 24 x 29	1650 x 600 x 735	QS31N_-S2466F	1,242
	60 x 24 x 29	1500 x 600 x 735	QS31N_-S2460F	1,211
	72 x 20 x 29	1800 x 500 x 735	QS31N_-S2072F	1,232
	66 x 20 x 29	1650 x 500 x 735	QS31N_-S2066F	1,201
60 x 20 x 29	1500 x 500 x 735	QS31N_-S2060F	1,176	
Specify the handle code (E, F).				

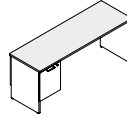
	W x D x H (in)	W x D x H (mm)	Code	Price (\$)
Left single pedestal credenzas – inner drawers 	<i>1 pedestal on left with lock. Pedestal with full-height front concealing 1 box drawer and 1 file drawer with suspension bar. Pencil tray. Recessed 3/4 height modesty panel.</i>			
	72 x 24 x 29	1800 x 600 x 735	QS31N_-IF2472S	1,152
	66 x 24 x 29	1650 x 600 x 735	QS31N_-IF2466S	1,127
	60 x 24 x 29	1500 x 600 x 735	QS31N_-IF2460S	1,096
	72 x 20 x 29	1800 x 500 x 735	QS31N_-IF2072S	1,119
	66 x 20 x 29	1650 x 500 x 735	QS31N_-IF2066S	1,088
60 x 20 x 29	1500 x 500 x 735	QS31N_-IF2060S	1,071	
Specify the handle code (E, F).				

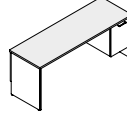
	W x D x H (in)	W x D x H (mm)	Code	Price (\$)
Right single pedestal credenzas – inner drawers 	<i>1 pedestal on right with lock. Pedestal with full-height front concealing 1 box drawer and 1 file drawer with suspension bar. Pencil tray. Recessed 3/4 height modesty panel.</i>			
	72 x 24 x 29	1800 x 600 x 735	QS31N_-S2472IF	1,152
	66 x 24 x 29	1650 x 600 x 735	QS31N_-S2466IF	1,127
	60 x 24 x 29	1500 x 600 x 735	QS31N_-S2460IF	1,096
	72 x 20 x 29	1800 x 500 x 735	QS31N_-S2072IF	1,119
	66 x 20 x 29	1650 x 500 x 735	QS31N_-S2066IF	1,088
60 x 20 x 29	1500 x 500 x 735	QS31N_-S2060IF	1,071	
Specify the handle code (E, F).				

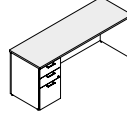
	W x D x H (in)	W x D x H (mm)	Code	Price (\$)
Left pedestal credenzas – low profile 	<i>1 pedestal on left with lock. 2 box drawers and 1 file drawer with suspension bar. Pencil tray. Recessed, full-height modesty panel.</i>			
	72 x 24 x 29	1800 x 600 x 735	QS31N_-UF2472S	1,597
	66 x 24 x 29	1650 x 600 x 735	QS31N_-UF2466S	1,546
	60 x 24 x 29	1500 x 600 x 735	QS31N_-UF2460S	1,518
	72 x 20 x 29	1800 x 500 x 735	QS31N_-UF2072S	1,546
	66 x 20 x 29	1650 x 500 x 735	QS31N_-UF2066S	1,518
60 x 20 x 29	1500 x 500 x 735	QS31N_-UF2060S	1,482	
Specify the handle code (E, F).				

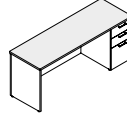
	W x D x H (in)	W x D x H (mm)	Code	Price (\$)
Right pedestal credenzas – low profile 	<i>1 pedestal on right with lock. 2 box drawers and 1 file drawer with suspension bar. Pencil tray. Recessed, full-height modesty panel.</i>			
	72 x 24 x 29	1800 x 600 x 735	QS31N_-S2472UF	1,597
	66 x 24 x 29	1650 x 600 x 735	QS31N_-S2466UF	1,546
	60 x 24 x 29	1500 x 600 x 735	QS31N_-S2460UF	1,518
	72 x 20 x 29	1800 x 500 x 735	QS31N_-S2072UF	1,546
	66 x 20 x 29	1650 x 500 x 735	QS31N_-S2066UF	1,518
60 x 20 x 29	1500 x 500 x 735	QS31N_-S2060UF	1,482	
Specify the handle code (E, F).				

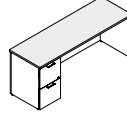
	W x D x H (in)	W x D x H (mm)	Code	Price (\$)
Left pedestal credenzas – low profile 	<i>1 pedestal on left with lock. 2 file drawers with suspension bars. Recessed, full-height modesty panel.</i>			
	72 x 24 x 29	1800 x 600 x 735	QS31N_-FF2472S	1,490
	66 x 24 x 29	1650 x 600 x 735	QS31N_-FF2466S	1,467
	60 x 24 x 29	1500 x 600 x 735	QS31N_-FF2460S	1,445
	72 x 20 x 29	1800 x 500 x 735	QS31N_-FF2072S	1,459
	66 x 20 x 29	1650 x 500 x 735	QS31N_-FF2066S	1,434
60 x 20 x 29	1500 x 500 x 735	QS31N_-FF2060S	1,395	
Specify the handle code (E, F).				

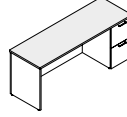
	W x D x H (in)	W x D x H (mm)	Code	Price (\$)
Right pedestal credenzas – low profile 	<i>1 pedestal on right with lock. 2 file drawers with suspension bars. Recessed, full-height modesty panel.</i>			
	72 x 24 x 29	1800 x 600 x 735	QS31N_-S2472FF	1,490
	66 x 24 x 29	1650 x 600 x 735	QS31N_-S2466FF	1,467
	60 x 24 x 29	1500 x 600 x 735	QS31N_-S2460FF	1,445
	72 x 20 x 29	1800 x 500 x 735	QS31N_-S2072FF	1,459
	66 x 20 x 29	1650 x 500 x 735	QS31N_-S2066FF	1,434
60 x 20 x 29	1500 x 500 x 735	QS31N_-S2060FF	1,395	
Specify the handle code (E, F).				

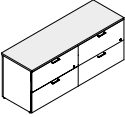
	W x D x H (in)	W x D x H (mm)	Code	Price (\$)
Lateral file credenza	<i>4 file drawers with suspension bars. Locks.</i>			
	72 x 24 x 29	1800 x 600 x 735	QS31N_-LF2472LF	2,566
	Specify the handle code (E, F).			

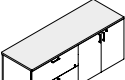
Lateral file/bookcase credenzas	<i>2 file drawers with suspension bars. Bookcase unit with doors and adjustable shelf. Locks.</i>			
	72 x 24 x 29	1800 x 600 x 735	QS31N_-LF2472B	2,081
	72 x 20 x 29	1800 x 500 x 735	QS31N_-LF2072B	1,918
	Specify the handle code (E, F).			

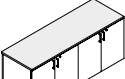
Bookcase credenzas	<i>2 bookcase units with doors. 1 adjustable shelf on each side. Locks.</i>			
	72 x 24 x 29	1800 x 600 x 735	QS31N_-B2472B	1,877
	72 x 20 x 29	1800 x 500 x 735	QS31N_-B2072B	1,725
	Specify the handle code (E, F).			

RETURNS

Left executive returns	<i>1 pedestal on left with lock. 1 box drawer and 1 file drawer with suspension bar. Pencil tray. Recessed 3/4 height modesty panel. Grommet.</i>			
	48 x 24 x 29	1200 x 600 x 735	QS31N_-F2448R	1,071
	42 x 24 x 29	1050 x 600 x 735	QS31N_-F2442R	1,008
	48 x 20 x 29	1200 x 500 x 735	QS31N_-F2048R	1,015
	42 x 20 x 29	1050 x 500 x 735	QS31N_-F2042R	984
	Specify the handle code (E, F).			

Right executive returns	<i>1 pedestal on right with lock. 1 box drawer and 1 file drawer with suspension bar. Pencil tray. Recessed 3/4 height modesty panel. Grommet.</i>			
	48 x 24 x 29	1200 x 600 x 735	QS31N_-R2448F	1,071
	42 x 24 x 29	1050 x 600 x 735	QS31N_-R2442F	1,008
	48 x 20 x 29	1200 x 500 x 735	QS31N_-R2048F	1,015
	42 x 20 x 29	1050 x 500 x 735	QS31N_-R2042F	984
	Specify the handle code (E, F).			

Left executive returns – inner drawers	<i>1 pedestal on left with lock. Pedestal with full-height front concealing 1 box drawer and 1 file drawer with suspension bar. Pencil tray. Recessed 3/4 height modesty panel. Grommet.</i>			
	48 x 24 x 29	1200 x 600 x 735	QS31N_-IF2448R	993
	42 x 24 x 29	1050 x 600 x 735	QS31N_-IF2442R	926
	48 x 20 x 29	1200 x 500 x 735	QS31N_-IF2048R	935
	42 x 20 x 29	1050 x 500 x 735	QS31N_-IF2042R	912
	Specify the handle code (E, F).			

Right executive returns – inner drawers	<i>1 pedestal on right with lock. Pedestal with full-height front concealing 1 box drawer and 1 file drawer with suspension bar. Pencil tray. Recessed 3/4 height modesty panel. Grommet.</i>			
	48 x 24 x 29	1200 x 600 x 735	QS31N_-R2448IF	993
	42 x 24 x 29	1050 x 600 x 735	QS31N_-R2442IF	926
	48 x 20 x 29	1200 x 500 x 735	QS31N_-R2048IF	935
	42 x 20 x 29	1050 x 500 x 735	QS31N_-R2042IF	912
	Specify the handle code (E, F).			

Left executive returns – low profile	<i>1 pedestal on left with lock. 2 box drawers and 1 file drawer with suspension bar. Pencil tray. Recessed, full-height modesty panel. Grommet.</i>			
	48 x 24 x 29	1200 x 600 x 735	QS31N_-UF2448R	1,434
	42 x 24 x 29	1050 x 600 x 735	QS31N_-UF2442R	1,345
	48 x 20 x 29	1200 x 500 x 735	QS31N_-UF2048R	1,355
	42 x 20 x 29	1050 x 500 x 735	QS31N_-UF2042R	1,317
	Specify the handle code (E, F).			

	W x D x H (in)	W x D x H (mm)	Code	Price (\$)
Right executive returns – low profile	<i>1 pedestal on right with lock. 2 box drawers and 1 file drawer with suspension bar. Pencil tray. Recessed, full-height modesty panel. Grommet.</i>			
	48 x 24 x 29	1200 x 600 x 735	QS31N_-R2448UF	1,434
	42 x 24 x 29	1050 x 600 x 735	QS31N_-R2442UF	1,345
	48 x 20 x 29	1200 x 500 x 735	QS31N_-R2048UF	1,355
	42 x 20 x 29	1050 x 500 x 735	QS31N_-R2042UF	1,317
	Specify the handle code (E, F).			

Bridge-returns	<i>Recessed 3/4 height modesty panel. Grommet.</i>			
	48 x 24 x 29	1200 x 600 x 735	QS31NN-BR2448	444
	42 x 24 x 29	1050 x 600 x 735	QS31NN-BR2442	427
	36 x 24 x 29	900 x 600 x 735	QS31NN-BR2436	410
	48 x 20 x 29	1200 x 500 x 735	QS31NN-BR2048	402
	42 x 20 x 29	1050 x 500 x 735	QS31NN-BR2042	388
	36 x 20 x 29	900 x 500 x 735	QS31NN-BR2036	363

HUTCHES

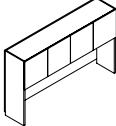
Hutches with laminate doors – 44" H	<i>Clearance: 26 1/2" (673 mm). Grommet on back. Full-width wire access. Can accommodate a tackboard. 1 tone only.</i>			
	84 x 16 x 44	2100 x 400 x 1099	QS3NNN-E844416P	1,597
	78 x 16 x 44	1950 x 400 x 1099	QS3NNN-E784416P	1,525
	72 x 16 x 44	1800 x 400 x 1099	QS3NNN-E724416P	1,467
	66 x 16 x 44	1650 x 400 x 1099	QS3NNN-E664416P	1,411
	60 x 16 x 44	1500 x 400 x 1099	QS3NNN-E604416P	1,345
	54 x 16 x 44	1350 x 400 x 1099	QS3NNN-E544416P	1,289
	48 x 16 x 44	1200 x 400 x 1099	QS3NNN-E484416P	1,225
	42 x 16 x 44	1050 x 400 x 1099	QS3NNN-E424416P	1,144
	36 x 16 x 44	900 x 400 x 1099	QS3NNN-E364416P	1,054

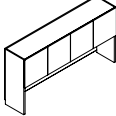
Hutches with laminate doors – 36" H	<i>Clearance: 18 5/8" (473 mm). Grommet on back. Full-width wire access. Can accommodate a tackboard. 1 tone only.</i>			
	84 x 16 x 36	2100 x 400 x 900	QS3NNN-E843616P	1,475
	78 x 16 x 36	1950 x 400 x 900	QS3NNN-E783616P	1,395
	72 x 16 x 36	1800 x 400 x 900	QS3NNN-E723616P	1,329
	66 x 16 x 36	1650 x 400 x 900	QS3NNN-E663616P	1,256
	60 x 16 x 36	1500 x 400 x 900	QS3NNN-E603616P	1,182
	54 x 16 x 36	1350 x 400 x 900	QS3NNN-E543616P	1,127
	48 x 16 x 36	1200 x 400 x 900	QS3NNN-E483616P	1,054
	42 x 16 x 36	1050 x 400 x 900	QS3NNN-E423616P	960
	36 x 16 x 36	900 x 400 x 900	QS3NNN-E363616P	877

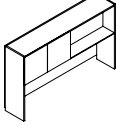
Hutches with 2 doors on left – 44" H	<i>Clearance: 26 1/2" (673 mm). 2 doors on left. Open storage on right. Grommet on back. Full-width wire access. Can accommodate a tackboard. 1 tone only.</i>			
	84 x 16 x 44	2100 x 400 x 1099	QS3NNN-E844416PL	1,371
	78 x 16 x 44	1950 x 400 x 1099	QS3NNN-E784416PL	1,306
	72 x 16 x 44	1800 x 400 x 1099	QS3NNN-E724416PL	1,232
	66 x 16 x 44	1650 x 400 x 1099	QS3NNN-E664416PL	1,169
	60 x 16 x 44	1500 x 400 x 1099	QS3NNN-E604416PL	1,096
	54 x 16 x 44	1350 x 400 x 1099	QS3NNN-E544416PL	1,021
	48 x 16 x 44	1200 x 400 x 1099	QS3NNN-E484416PL	951

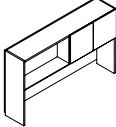
Hutches with 2 doors on right – 44" H	<i>Clearance: 26 1/2" (673 mm). 2 doors on right. Open storage on left. Grommet on back. Full-width wire access. Can accommodate a tackboard. 1 tone only.</i>			
	84 x 16 x 44	2100 x 400 x 1099	QS3NNN-E844416PR	1,371
	78 x 16 x 44	1950 x 400 x 1099	QS3NNN-E784416PR	1,306
	72 x 16 x 44	1800 x 400 x 1099	QS3NNN-E724416PR	1,232
	66 x 16 x 44	1650 x 400 x 1099	QS3NNN-E664416PR	1,169
	60 x 16 x 44	1500 x 400 x 1099	QS3NNN-E604416PR	1,096
	54 x 16 x 44	1350 x 400 x 1099	QS3NNN-E544416PR	1,021
	48 x 16 x 44	1200 x 400 x 1099	QS3NNN-E484416PR	951

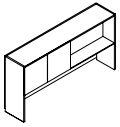
	W x D x H (in)	W x D x H (mm)	Code	Price (\$)
Hutches with 2 doors on left – 36" H 	<i>Clearance: 18 3/8" (473 mm). 2 doors on left. Open storage on right. Grommet on back. Full-width wire access. Can accommodate a tackboard. 1 tone only.</i>			
	84 x 16 x 36	2100 x 400 x 900	QS3NNN-E843616PL	1,242
	78 x 16 x 36	1950 x 400 x 900	QS3NNN-E783616PL	1,176
	72 x 16 x 36	1800 x 400 x 900	QS3NNN-E723616PL	1,119
	66 x 16 x 36	1650 x 400 x 900	QS3NNN-E663616PL	1,065
	60 x 16 x 36	1500 x 400 x 900	QS3NNN-E603616PL	998
	54 x 16 x 36	1350 x 400 x 900	QS3NNN-E543616PL	935
48 x 16 x 36	1200 x 400 x 900	QS3NNN-E483616PL	877	

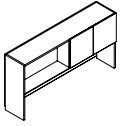
	W x D x H (in)	W x D x H (mm)	Code	Price (\$)
Hutches with 2 doors on right – 36" H 	<i>Clearance: 18 3/8" (473 mm). 2 doors on right. Open storage on left. Grommet on back. Full-width wire access. Can accommodate a tackboard. 1 tone only.</i>			
	84 x 16 x 36	2100 x 400 x 900	QS3NNN-E843616PR	1,242
	78 x 16 x 36	1950 x 400 x 900	QS3NNN-E783616PR	1,176
	72 x 16 x 36	1800 x 400 x 900	QS3NNN-E723616PR	1,119
	66 x 16 x 36	1650 x 400 x 900	QS3NNN-E663616PR	1,065
	60 x 16 x 36	1500 x 400 x 900	QS3NNN-E603616PR	998
	54 x 16 x 36	1350 x 400 x 900	QS3NNN-E543616PR	935
48 x 16 x 36	1200 x 400 x 900	QS3NNN-E483616PR	877	

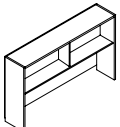
	W x D x H (in)	W x D x H (mm)	Code	Price (\$)
Open hutches – 44" H 	<i>Clearance: 26 1/2" (673 mm). Grommet on back. Full-width wire access. Can accommodate a tackboard, refer to page 147. 1 tone only.</i>			
	84 x 16 x 44	2100 x 400 x 1099	QS3NNN-E844416	1,232
	78 x 16 x 44	1950 x 400 x 1099	QS3NNN-E784416	1,169
	72 x 16 x 44	1800 x 400 x 1099	QS3NNN-E724416	1,102
	66 x 16 x 44	1650 x 400 x 1099	QS3NNN-E664416	1,054
	60 x 16 x 44	1500 x 400 x 1099	QS3NNN-E604416	993
	54 x 16 x 44	1350 x 400 x 1099	QS3NNN-E544416	926
48 x 16 x 44	1200 x 400 x 1099	QS3NNN-E484416	870	
42 x 16 x 44	1050 x 400 x 1099	QS3NNN-E424416	805	
36 x 16 x 44	900 x 400 x 1099	QS3NNN-E364416	766	

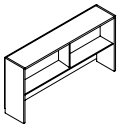
	W x D x H (in)	W x D x H (mm)	Code	Price (\$)
Open hutches – 36" H 	<i>Clearance: 18 3/8" (473 mm). Grommet on back. Full-width wire access. Can accommodate a tackboard, refer to page 147. 1 tone only.</i>			
	84 x 16 x 36	2100 x 400 x 900	QS3NNN-E843616	1,047
	78 x 16 x 36	1950 x 400 x 900	QS3NNN-E783616	984
	72 x 16 x 36	1800 x 400 x 900	QS3NNN-E723616	918
	66 x 16 x 36	1650 x 400 x 900	QS3NNN-E663616	862
	60 x 16 x 36	1500 x 400 x 900	QS3NNN-E603616	798
	54 x 16 x 36	1350 x 400 x 900	QS3NNN-E543616	742
48 x 16 x 36	1200 x 400 x 900	QS3NNN-E483616	686	
42 x 16 x 36	1050 x 400 x 900	QS3NNN-E423616	613	
36 x 16 x 36	900 x 400 x 900	QS3NNN-E363616	570	

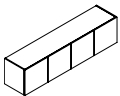
	W x D x H (in)	W x D x H (mm)	Code	Price (\$)
Wall-mounted hutches with doors – 17" H  84" to 60": 4 doors 54" to 48": 3 doors 42" to 36": 2 doors	<i>Hanger bar included for wall-mount installation. Can accommodate a tackboard. 1 tone only.</i>			
	84 x 16 x 17	2100 x 400 x 427	QS3NNN-EM841716P	1,459
	78 x 16 x 17	1950 x 400 x 427	QS3NNN-EM781716P	1,379
	72 x 16 x 17	1800 x 400 x 427	QS3NNN-EM721716P	1,322
	66 x 16 x 17	1650 x 400 x 427	QS3NNN-EM661716P	1,249
	60 x 16 x 17	1500 x 400 x 427	QS3NNN-EM601716P	1,176
	54 x 16 x 17	1350 x 400 x 427	QS3NNN-EM541716P	1,119
	48 x 16 x 17	1200 x 400 x 427	QS3NNN-EM481716P	1,047
	42 x 16 x 17	1050 x 400 x 427	QS3NNN-EM421716P	951
	36 x 16 x 17	900 x 400 x 427	QS3NNN-EM361716P	870

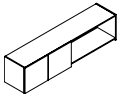
	W x D x H (in)	W x D x H (mm)	Code	Price (\$)
Wall-mounted hutches with 2 doors on left – 17" H 	<i>2 doors on left. Open storage on right. Hanger bar included for wall-mount installation. Can accommodate a tackboard. 1 tone only.</i>			
	84 x 16 x 17	2100 x 400 x 427	QS3NNN-EM841716L	1,232
	78 x 16 x 17	1950 x 400 x 427	QS3NNN-EM781716L	1,169
	72 x 16 x 17	1800 x 400 x 427	QS3NNN-EM721716L	1,102
	66 x 16 x 17	1650 x 400 x 427	QS3NNN-EM661716L	1,054
	60 x 16 x 17	1500 x 400 x 427	QS3NNN-EM601716L	993
	54 x 16 x 17	1350 x 400 x 427	QS3NNN-EM541716L	926
48 x 16 x 17	1200 x 400 x 427	QS3NNN-EM481716L	870	

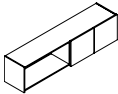
	W x D x H (in)	W x D x H (mm)	Code	Price (\$)
Wall-mounted hutches with 2 doors on right – 17" H 	<i>2 doors on right. Open storage on left. Hanger bar included for wall-mount installation. Can accommodate a tackboard. 1 tone only.</i>			
	84 x 16 x 17	2100 x 400 x 427	QS3NNN-EM841716R	1,232
	78 x 16 x 17	1950 x 400 x 427	QS3NNN-EM781716R	1,169
	72 x 16 x 17	1800 x 400 x 427	QS3NNN-EM721716R	1,102
	66 x 16 x 17	1650 x 400 x 427	QS3NNN-EM661716R	1,054
	60 x 16 x 17	1500 x 400 x 427	QS3NNN-EM601716R	993
	54 x 16 x 17	1350 x 400 x 427	QS3NNN-EM541716R	926
48 x 16 x 17	1200 x 400 x 427	QS3NNN-EM481716R	870	

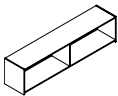
	W x D x H (in)	W x D x H (mm)	Code	Price (\$)
Wall-mounted open hutches – 17" H 	<i>Hanger bar included for wall-mount installation. Can accommodate a tackboard. 1 tone only.</i>			
	84 x 16 x 17	2100 x 400 x 427	QS3NNN-EM841716	1,041
	78 x 16 x 17	1950 x 400 x 427	QS3NNN-EM781716	973
	72 x 16 x 17	1800 x 400 x 427	QS3NNN-EM721716	912
	66 x 16 x 17	1650 x 400 x 427	QS3NNN-EM661716	856
	60 x 16 x 17	1500 x 400 x 427	QS3NNN-EM601716	791
	54 x 16 x 17	1350 x 400 x 427	QS3NNN-EM541716	731
48 x 16 x 17	1200 x 400 x 427	QS3NNN-EM481716	677	
42 x 16 x 17	1050 x 400 x 427	QS3NNN-EM421716	605	
36 x 16 x 17	900 x 400 x 427	QS3NNN-EM361716	563	

MODULAR STORAGE FURNITURE

	W x D x H (in)	W x D x H (mm)	Code	Price (\$)
Modular lateral files 	<i>2 file drawers with suspension bars. Lock. Goes under a work surface. 1 tone only.</i>			
	36 x 18 x 28	900 x 448 x 711	QS3NN_-1836LFL	1,242
	30 x 18 x 28	750 x 448 x 711	QS3NN_-1830LFL	1,176
Specify the handle code (E, F).				

	W x D x H (in)	W x D x H (mm)	Code	Price (\$)
Modular combined pedestals 	<i>2 box drawers on left, 2 file drawers with suspension bars. Lock. Pencil tray. Goes under a work surface. 1 tone only.</i>			
	36 x 18 x 28	900 x 448 x 711	QS3NN_-1836COL	1,597
	30 x 18 x 28	750 x 448 x 711	QS3NN_-1830COL	1,538
Specify the handle code (E, F).				

	W x D x H (in)	W x D x H (mm)	Code	Price (\$)
Modular combined pedestals 	<i>2 box drawers on right, 2 file drawers with suspension bars. Lock. Pencil tray. Goes under a work surface. 1 tone only.</i>			
	36 x 18 x 28	900 x 448 x 711	QS3NN_-C01836L	1,597
	30 x 18 x 28	750 x 448 x 711	QS3NN_-C01830L	1,538
Specify the handle code (E, F).				

	W x D x H (in)	W x D x H (mm)	Code	Price (\$)
Modular bookcases with doors 	<i>1 adjustable shelf. Lock. Goes under a work surface. 1 tone only.</i>			
	36 x 18 x 28	900 x 448 x 711	QS3NN_-1836BL	967
	30 x 18 x 28	750 x 448 x 711	QS3NN_-1830BL	862
Specify the handle code (E, F).				

	W x D x H (in)	W x D x H (mm)	Code	Price (\$)
STORAGE FURNITURE				
Lateral file units	<i>2 file drawers with suspension bars. Lock.</i>			
	36 x 24 x 29	900 x 600 x 735	QS31N_-2436LF	1,329
	30 x 24 x 29	750 x 600 x 735	QS31N_-2430LF	1,264
	36 x 20 x 29	900 x 500 x 735	QS31N_-2036LF	1,274
	30 x 20 x 29	750 x 500 x 735	QS31N_-2030LF	1,211
	Specify the handle code (E, F).			

Combined units	<i>2 box drawers on left, 2 file drawers with suspension bars. One lock for two file drawers.</i>			
	36 x 24 x 29	900 x 600 x 736	QS31N_-2436CO	1,676
	36 x 20 x 29	900 x 500 x 736	QS31N_-2036CO	1,628
	Specify the handle code (E, F).			

Combined units	<i>2 box drawers on right, 2 file drawers with suspension bars. One lock for two file drawers.</i>			
	36 x 24 x 29	900 x 600 x 736	QS31N_-C02436	1,676
	36 x 20 x 29	900 x 500 x 736	QS31N_-C02036	1,628
	Specify the handle code (E, F).			

Bookcase units	<i>Bookcase with doors and adjustable shelf. Loc</i>			
	36 x 24 x 29	900 x 600 x 735	QS31N_-2436B	1,054
	30 x 24 x 29	750 x 600 x 735	QS31N_-2430B	993
	36 x 20 x 29	900 x 500 x 735	QS31N_-2036B	1,008
	30 x 20 x 29	750 x 500 x 735	QS31N_-2030B	942
	Specify the handle code (E, F).			

Open bookcase units	<i>Adjustable shelf.</i>			
	36 x 24 x 29	900 x 600 x 735	QS31NN-2436BE	960
	30 x 24 x 29	750 x 600 x 735	QS31NN-2430BE	912
	36 x 20 x 29	900 x 500 x 735	QS31NN-2036BE	926
	30 x 20 x 29	750 x 500 x 735	QS31NN-2030BE	877

Bookcase with doors/lateral file units	<i>Bookcase with doors, 2 adjustable shelves. 2 file drawers with suspension bars. Lock on drawers. 1 tone only.</i>			
	36 x 24 x 73	900 x 600 x 1834	QS3NN_-243673LFB	2,135
	36 x 20 x 73	900 x 500 x 1834	QS3NN_-203673LFB	2,057
	36 x 24 x 65	900 x 600 x 1635	QS3NN_-243665LFB	2,071
	36 x 20 x 65	900 x 500 x 1635	QS3NN_-203665LFB	1,988
	Specify the handle code (E, F).			

Open bookcase/lateral file units	<i>Open bookcase, 2 adjustable shelves. 2 file drawers with suspension bars. Lock on drawers. 1 tone only.</i>			
	36 x 24 x 73	900 x 600 x 1834	QS3NN_-243673LFE	1,904
	36 x 20 x 73	900 x 500 x 1834	QS3NN_-203673LFE	1,821
	36 x 24 x 65	900 x 600 x 1635	QS3NN_-243665LFE	1,838
	36 x 20 x 65	900 x 500 x 1635	QS3NN_-203665LFE	1,766
	Specify the handle code (E, F).			

Storage with door/lateral file units	<i>Bookcase with door, 2 adjustable shelves. 2 file drawers with suspension bars. Lock on drawers. Reversible door. 1 tone only.</i>			
	24 x 24 x 73	600 x 600 x 1834	QS3NN_-242473FB	1,732
	24 x 20 x 73	600 x 500 x 1834	QS3NN_-202473FB	1,660
	24 x 24 x 65	600 x 600 x 1635	QS3NN_-242465FB	1,676
	24 x 20 x 65	600 x 500 x 1635	QS3NN_-202465FB	1,621
	Specify the handle code (E, F).			

	W x D x H (in)	W x D x H (mm)	Code	Price (\$)
Storage/wardrobe units with doors	<i>3 adjustable shelves. 1 full-width fixed shelf. Full-width clothes hanger bar. 1 tone only.</i>			
	36 x 24 x 73	900 x 600 x 1834	QS3NN_-243673B	1,942
	36 x 20 x 73	900 x 500 x 1834	QS3NN_-203673B	1,798
	36 x 24 x 65	900 x 600 x 1635	QS3NN_-243665B	1,838
	36 x 20 x 65	900 x 500 x 1635	QS3NN_-203665B	1,676
	Specify the handle code (E, F).			

Storage/wardrobe units with door	<i>3 adjustable shelves. 1 full-width fixed shelf. Full-width clothes hanger bar. Reversible door. 1 tone only.</i>			
	24 x 24 x 73	600 x 600 x 1834	QS3NN_-242473B	1,490
	24 x 20 x 73	600 x 500 x 1834	QS3NN_-202473B	1,411
	24 x 24 x 65	600 x 600 x 1635	QS3NN_-242465B	1,411
	24 x 20 x 65	600 x 500 x 1635	QS3NN_-202465B	1,335
	Specify the handle code (E, F).			

Open bookcases	<i>73" to 65": 3 adjustable shelves, 1 fixed shelf. 48": 2 adjustable shelves. 1 tone only.</i>			
	36 x 14 x 73	900 x 350 x 1834	QS3NNN-B367314	960
	36 x 14 x 65	900 x 350 x 1635	QS3NNN-B366514	896
	36 x 14 x 48	900 x 350 x 1212	QS3NNN-B364814	798

Additional shelf	<i>1 tone only.</i>			
	34 x 13 x 5/8	864 x 330 x 16	QS3NNN-TB3614	153

MODULAR PEDESTALS

Modular pedestal	<i>2 box drawers, 1 file drawer with suspension bar. Lock. Pencil tray. Must be installed under a work surface. 1 tone only.</i>			
	15 x 18 x 28	388 x 448 x 711	QS3NN_-P1518UFL	1,041
	Specify the handle code (E, F).			

Modular pedestal	<i>2 file drawers with suspension bars. Lock. Must be installed under a work surface. 1 tone only.</i>			
	15 x 18 x 28	388 x 448 x 711	QS3NN_-P1518FFL	998
	Specify the handle code (E, F).			





Hanging pedestal	<i>1 box drawer, 1 file drawer with suspension bar. Lock. Pencil tray. Must be installed under a work surface. 1 tone only.</i>			
	15 x 18 x 19 1/4	388 x 448 x 489	QS3NN_-F	918
	Specify the handle code (E, F).			

Hanging pedestal - inner drawers	<i>Pedestal with full-height front concealing 1 box drawer and 1 file drawer with suspension bar. Lock. Pencil tray. Must be installed under a work surface. 1 tone only.</i>			
	15 x 18 x 19 1/4	388 x 448 x 489	QS3NN_-IF	752
	Specify the handle code (E, F).			

PEDESTALS

Mobile pedestal	<i>2 box drawers, 1 file drawer with suspension bar. Brakes on front casters. Lock. Pencil tray. Fits under a work surface. 1 tone only.</i>			
	15 x 18 x 27 1/8	390 x 450 x 689	QS3NN_-MP1518UF	1,127
	Specify the handle code (E, F).			

Mobile pedestal	<i>2 box drawers, 1 file drawer with suspension bar. Brakes on front casters. Lock. Pencil tray. Fits under a work surface. 1 tone only.</i>			
	15 x 22 x 27 1/8	390 x 550 x 689	QS3NN_-MP1522UF	1,211
	Specify the handle code (E, F).			

	W x D x H (in)	W x D x H (mm)	Code	Price (\$)
Mobile pedestal 	<i>2 file drawers with suspension bars. Brakes on front casters. Lock. Fits under a work surface. 1 tone only.</i>			
	15 x 22 x 27 ¹ / ₈	390 x 550 x 689	QS3NN_-MP1522FF	1,169
	Specify the handle code (E, F).			
Mobile pedestal 	<i>1 box drawer, 1 file drawer with suspension bar. Brakes on front casters. Lock. Pencil tray. Fits under a work surface. 1 tone only.</i>			
	15 x 18 x 20 ³ / ₄	390 x 450 x 527	QS3NN_-MP1518F	1,041
	Specify the handle code (E, F).			
Mobile pedestal 	<i>1 box drawer, 1 file drawer with suspension bar. Pencil tray. Brakes on front casters. Lock. Fits under a work surface. 1 tone only.</i>			
	15 x 22 x 20 ³ / ₄	390 x 550 x 527	QS3NN_-MP1522F	1,065
	Specify the handle code (E, F).			
Mobile pedestal – inner drawers 	<i>Pedestal with full-height front concealing 1 box drawer and 1 file drawer with suspension bar. Brakes on front casters. Lock. Pencil tray. Fits under a work surface. 1 tone only.</i>			
	15 x 18 x 20 ³ / ₄	390 x 450 x 527	QS3NN_-MP1518IF	885
	Specify the handle code (E, F).			

SUGGESTIONS

31NE-PLAN01

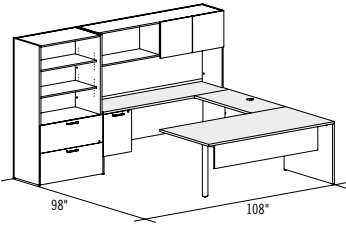

Plan shown in Concept 300 Flyer:

QS31NE-PLAN01	\$5,393
1 QS31NN-RTM3672	
1 QS31NN-BR2042	
1 QS31NE-IF2072S	
1 QS3NNN-E723616PR	
1 QS3NNE-203665LFE	

Square pull (E).

31NF-PLAN03

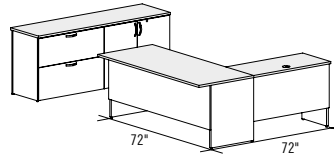

Plan shown in Concept 300 Flyer:

QS31NF-PLAN03	\$4,192
1 QS31NF-S3072F	
1 QS31NE-IF2042R	
1 QS31NF-LF2072B	

Round pull (F).

31NF-PLAN02

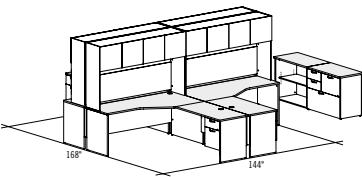

Plan shown in Concept 300 Flyer:

QS31NF-PLAN02	\$17,380
2 QS31NN-CM723624A	
2 QS31NN-CM367224A	
2 QS31NF-F2448R	
2 QS31NF-R2448F	
4 QS3NNN-E724416P	
1 QS31NF-2036CO	
1 QS31NN-2036BE	

Round pull (F).

31NE-PLAN04

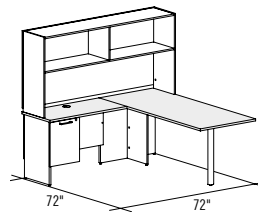

Plan shown in Concept 300 Flyer:

QS31NE-PLAN04	\$2,651
1 QS31NN-RT3072	
1 QS31NE-IF2042R	
1 QS3NNN-E723616	

Square pull (E).

TYPICAL WOOD GRAIN DIRECTION FOR CONCEPT 300:

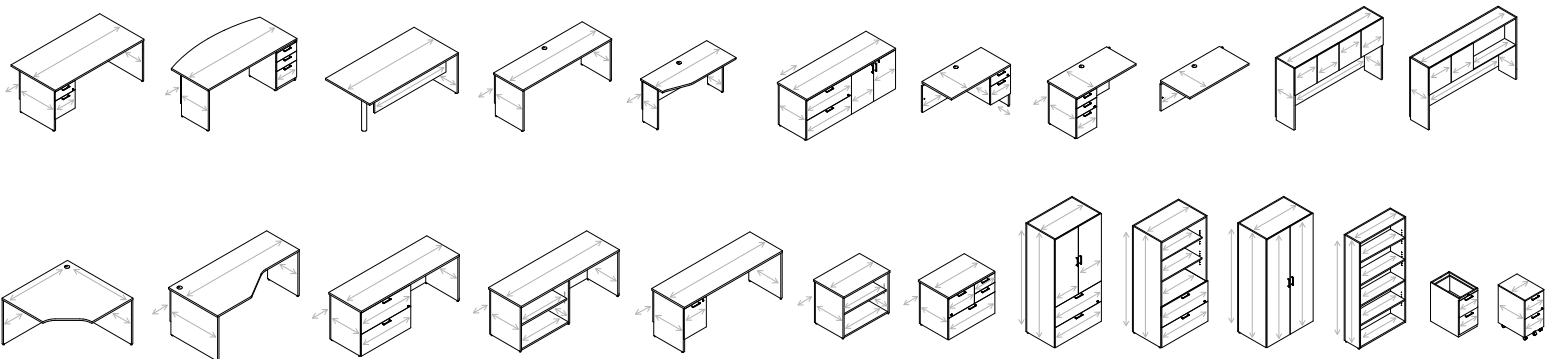

2-TONE LAMINATE APPLICATION: SHADED AREA CORRESPONDS TO THE FIRST CODE TO BE SPECIFIED. SECOND LAMINATE CODE WILL BE APPLIED TO THE REST OF THE PRODUCT.