

LACASSE QUICKSHIP PROGRAM

> CONCEPT 400E

LACASSE QUICKSHIP PROGRAM*

Products and suggested layouts identified by this pictogram are part of the Lacasse quick delivery program.

* Due to current market conditions, always refer to our Lead-Time Guide for a confirmation of our current Lacasse QuickShip lead-times.



PROGRAM CONDITIONS AND LIMITATIONS:

- Maximum of 35 of each selected item and of each color per order.
- QuickShip products are ready for shipment **after reception of a ready-to-process order and delivered on next available trailer.**

IMPORTANT:

Place QuickShip orders separately from regular Lacasse orders.

When preparing QuickShip orders, indicate the code "QS" in front of the product code or the suggested layout code, i.e.: **QS41NN-F3672F.**

AVAILABLE OPTIONS AND FINISHES:

Make sure to complete QuickShip product codes with the options and finish codes that are part of the QuickShip program. See below for the complete list of QuickShip options and finishes relevant to the Concept 400E collection:

- **HANDLES**
L, X, Y



Please refer to the current LACASSE General Price Book to see all the collections and the details of the product offering.

CONCEPT 400E - QUICKSHIP PROGRAM

N EDGEBANDING

Furniture with 1" (25 mm) thick tops.

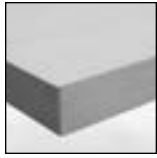

Smooth, 1/16" (1,5 mm) thick edge. The N edge is matched with the finish specified for the surface.

N Edge

HANDLES

Choices of straight pulls in thermoplastic polymer or metal available.



L – Black Linear



X – Stainless Steel



Y – Aluminum



N – Non applicable
Linear pull on the interior side

CODIFICATION

Series	Options		
	Thickness	Handles	Accent
QS4	1 Thermofused laminate 1"	L Black Linear X Stainless Steel Y Aluminum	N/A

	W x D x H (in)	W x D x H (mm)	Code	Price (\$)
Double pedestal desks	<i>2 pedestals with locks, 2 box drawers and 2 file drawers with suspension bars. Pencil tray. Recessed, full-height modesty panel.</i>			
	72 x 36 x 29	1800 x 900 x 735	QS41_N-F3672F	2,014
	72 x 30 x 29	1800 x 750 x 735	QS41_N-F3072F	1,942
	66 x 30 x 29	1650 x 750 x 735	QS41_N-F3066F	1,869
	60 x 30 x 29	1500 x 750 x 735	QS41_N-F3060F	1,786
	<i>2 full-height pedestals option.</i>			
	72 x 36 x 29	1800 x 900 x 735	QS41_N-UF3672FF	2,415
	72 x 30 x 29	1800 x 750 x 735	QS41_N-UF3072FF	2,343
	66 x 30 x 29	1650 x 750 x 735	QS41_N-UF3066FF	2,270
	60 x 30 x 29	1500 x 750 x 735	QS41_N-UF3060FF	2,187

Specify the handle code (X, Y, N).

	W x D x H (in)	W x D x H (mm)	Code	Price (\$)
Double pedestal bow front desk	<i>2 pedestals with locks, 2 box drawers and 2 file drawers with suspension bars. Pencil tray. Recessed, full-height modesty panel.</i>			
	72 x 42 x 29	1800 x 1050 x 735	QS41_N-F4272FA	2,376
	<i>2 full-height pedestals option.</i>			
	72 x 42 x 29	1800 x 1050 x 735	QS41_N-UF4272FFA	2,778

Specify the handle code (X, Y, N).

	W x D x H (in)	W x D x H (mm)	Code	Price (\$)
Left single pedestal desks	<i>1 pedestal on left with lock, 1 box drawer and 1 file drawer with suspension bar. Pencil tray. Recessed, full-height modesty panel.</i>			
	72 x 36 x 29	1800 x 900 x 735	QS41_N-F3672S	1,621
	72 x 30 x 29	1800 x 750 x 735	QS41_N-F3072S	1,546
	66 x 30 x 29	1650 x 750 x 735	QS41_N-F3066S	1,467
	60 x 30 x 29	1500 x 750 x 735	QS41_N-F3060S	1,395
	48 x 30 x 29	1200 x 750 x 735	QS41_N-F3048S	1,289
	<i>Full-height pedestal option.</i>			
	72 x 36 x 29	1800 x 900 x 735	QS41_N-UF3672S	1,821
	72 x 30 x 29	1800 x 750 x 735	QS41_N-UF3072S	1,746
	66 x 30 x 29	1650 x 750 x 735	QS41_N-UF3066S	1,666
	60 x 30 x 29	1500 x 750 x 735	QS41_N-UF3060S	1,596
	48 x 30 x 29	1200 x 750 x 735	QS41_N-UF3048S	1,490

Specify the handle code (X, Y, N).

	W x D x H (in)	W x D x H (mm)	Code	Price (\$)
Right single pedestal desks	<i>1 pedestal on right with lock, 1 box drawer and 1 file drawer with suspension bar. Pencil tray. Recessed, full-height modesty panel.</i>			
	72 x 36 x 29	1800 x 900 x 735	QS41_N-S3672F	1,621
	72 x 30 x 29	1800 x 750 x 735	QS41_N-S3072F	1,546
	66 x 30 x 29	1650 x 750 x 735	QS41_N-S3066F	1,467
	60 x 30 x 29	1500 x 750 x 735	QS41_N-S3060F	1,395
	48 x 30 x 29	1200 x 750 x 735	QS41_N-S3048F	1,289

	W x D x H (in)	W x D x H (mm)	Code	Price (\$)
Right single pedestal desks (cont'd)	<i>Full-height pedestal option.</i>			
	72 x 36 x 29	1800 x 900 x 735	QS41_N-S3672UF	1,821
	72 x 30 x 29	1800 x 750 x 735	QS41_N-S3072UF	1,746
	66 x 30 x 29	1650 x 750 x 735	QS41_N-S3066UF	1,666
	60 x 30 x 29	1500 x 750 x 735	QS41_N-S3060UF	1,596
	48 x 30 x 29	1200 x 750 x 735	QS41_N-S3048UF	1,490

Specify the handle code (X, Y, N).

	W x D x H (in)	W x D x H (mm)	Code	Price (\$)
Left single pedestal bow front desk	<i>1 pedestal on left with lock, 1 box drawer and 1 file drawer with suspension bar. Pencil tray. Recessed, full-height modesty panel.</i>			
	72 x 42 x 29	1800 x 1050 x 735	QS41_N-F4272SA	1,983
	<i>Full height pedestal option.</i>			
	72 x 42 x 29	1800 x 1050 x 735	QS41_N-UF4272SA	2,184

Specify the handle code (X, Y, N).

	W x D x H (in)	W x D x H (mm)	Code	Price (\$)
Right single pedestal bow front desk	<i>1 pedestal on right with lock, 1 box drawer and 1 file drawer with suspension bar. Pencil tray. Recessed, full-height modesty panel.</i>			
	72 x 42 x 29	1800 x 1050 x 735	QS41_N-S4272FA	1,983
	<i>Full-height pedestal option.</i>			
	72 x 42 x 29	1800 x 1050 x 735	QS41_N-S4272UFA	2,184

Specify the handle code (X, Y, N).

	W x D x H (in)	W x D x H (mm)	Code	Price (\$)
Desk shells	<i>Recessed, full-height modesty panel. Can accommodate 1 or 2 pedestals.</i>			
	72 x 36 x 29	1800 x 900 x 735	QS41NN-TDM3672	1,071
	72 x 30 x 29	1800 x 750 x 735	QS41NN-TDM3072	1,033
	66 x 30 x 29	1650 x 750 x 735	QS41NN-TDM3066	993
	60 x 30 x 29	1500 x 750 x 735	QS41NN-TDM3060	942

	W x D x H (in)	W x D x H (mm)	Code	Price (\$)
Corner modules	<i>Full-height modesty panel. 1 grommet. Must be attached to another surface.</i>			
	48" x 48"	1200 x 1200	QS41NN-CM4830S	1,182
	42" x 42"	1050 x 1050	QS41NN-CM4224S	1,047
	36" x 36"	900 x 900	QS41NN-CM3624S	942
	36" x 36"	900 x 900	QS41NN-CM3618S	942

Diagonal wood grain: change S to D, add 10% to the price.

ASSEMBLY REQUIRED

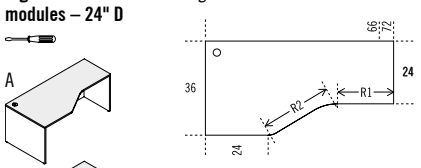
	W x D x H (in)	W x D x H (mm)	Code	Price (\$)	
Right extended corner modules – 24" D	<i>1 grommet.</i>				
			Surface 72"/36" 66"/36"	R1 21 1/8" (573 mm) 15 1/4" (387 mm)	R2 21 1/8" (573 mm) 28 3/8" (727 mm)
A	72 x 36 x 29	1800 x 900 x 735	QS41NN-CM367224_	1,411	
B	66 x 36 x 29	1650 x 900 x 735	QS41NN-CM366624_	1,322	
Specify panel legs (A, B).					

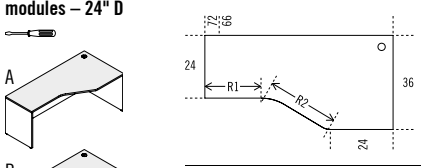
	W x D x H (in)	W x D x H (mm)	Code	Price (\$)	
Left extended corner modules – 24" D	<i>1 grommet.</i>				
			Surface 72"/36" 66"/36"	R1 21 1/8" (573 mm) 15 1/4" (387 mm)	R2 21 1/8" (573 mm) 28 3/8" (727 mm)
A	72 x 36 x 29	1800 x 900 x 735	QS41NN-CM723624_	1,411	
B	66 x 36 x 29	1650 x 900 x 735	QS41NN-CM663624_	1,322	
Specify panel legs (A, B).					

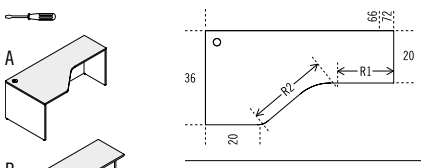
	W x D x H (in)	W x D x H (mm)	Code	Price (\$)	
Right extended corner modules – 20" D	<i>1 grommet.</i>				
			Surface 72"/36" 66"/36"	R1 23 9/16" (608 mm) 18 1/16" (459 mm)	R2 31 1/16" (799 mm) 31 1/16" (799 mm)
A	72 x 36 x 29	1800 x 900 x 735	QS41NN-CM367220_	1,411	
B	66 x 36 x 29	1650 x 900 x 735	QS41NN-CM366620_	1,322	
Specify panel legs (A, B).					

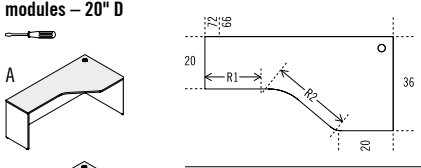
	W x D x H (in)	W x D x H (mm)	Code	Price (\$)	
Left extended corner modules – 20" D	<i>1 grommet.</i>				
			Surface 72"/36" 66"/36"	R1 23 9/16" (608 mm) 18 1/16" (459 mm)	R2 31 1/16" (799 mm) 31 1/16" (799 mm)
A	72 x 36 x 29	1800 x 900 x 735	QS41NN-CM723620_	1,411	
B	66 x 36 x 29	1650 x 900 x 735	QS41NN-CM663620_	1,322	
Specify panel legs (A, B).					

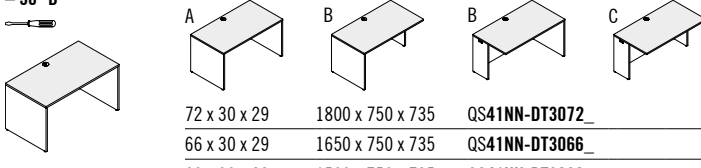
	W x D x H (in)	W x D x H (mm)	Code	Price (\$)
Rectangular tables – 30" D	<i>Full-height modesty panel. 1 grommet.</i>			
				
A	72 x 30 x 29	1800 x 750 x 735	QS41NN-DT3072_	1,008
B	66 x 30 x 29	1650 x 750 x 735	QS41NN-DT3066_	960
C	60 x 30 x 29	1500 x 750 x 735	QS41NN-DT3060_	918
D	54 x 30 x 29	1350 x 750 x 735	QS41NN-DT3054_	877
E	48 x 30 x 29	1200 x 750 x 735	QS41NN-DT3048_	839
F	42 x 30 x 29	1050 x 750 x 735	QS41NN-DT3042_	798
G	36 x 30 x 29	900 x 750 x 735	QS41NN-DT3036_	758
H	30 x 30 x 29	750 x 750 x 735	QS41NN-DT3030_	718
I	24 x 30 x 29	600 x 750 x 735	QS41NN-DT3024_	669
Specify panel legs (A, B, C).				

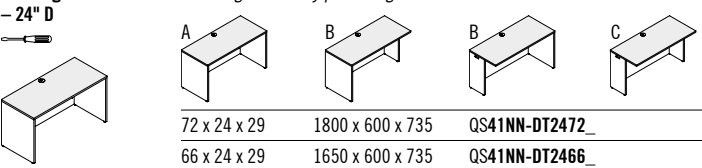
	W x D x H (in)	W x D x H (mm)	Code	Price (\$)
Rectangular tables – 24" D	<i>Full-height modesty panel. 1 grommet.</i>			
				
A	72 x 24 x 29	1800 x 600 x 735	QS41NN-DT2472_	973
B	66 x 24 x 29	1650 x 600 x 735	QS41NN-DT2466_	926
C	60 x 24 x 29	1500 x 600 x 735	QS41NN-DT2460_	885
D	54 x 24 x 29	1350 x 600 x 735	QS41NN-DT2454_	847
E	48 x 24 x 29	1200 x 600 x 735	QS41NN-DT2448_	805
F	42 x 24 x 29	1050 x 600 x 735	QS41NN-DT2442_	766
G	36 x 24 x 29	900 x 600 x 735	QS41NN-DT2436_	724
H	30 x 24 x 29	750 x 600 x 735	QS41NN-DT2430_	677
I	24 x 24 x 29	600 x 600 x 735	QS41NN-DT2424_	638
Specify panel legs (A, B, C).				

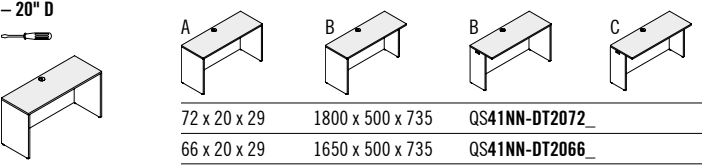
	W x D x H (in)	W x D x H (mm)	Code	Price (\$)
Rectangular tables – 20" D	<i>Full-height modesty panel. 1 grommet.</i>			
				
A	72 x 20 x 29	1800 x 500 x 735	QS41NN-DT2072_	935
B	66 x 20 x 29	1650 x 500 x 735	QS41NN-DT2066_	896
C	60 x 20 x 29	1500 x 500 x 735	QS41NN-DT2060_	856
D	54 x 20 x 29	1350 x 500 x 735	QS41NN-DT2054_	813
E	48 x 20 x 29	1200 x 500 x 735	QS41NN-DT2048_	773
F	42 x 20 x 29	1050 x 500 x 735	QS41NN-DT2042_	731
G	36 x 20 x 29	900 x 500 x 735	QS41NN-DT2036_	686
H	30 x 20 x 29	750 x 500 x 735	QS41NN-DT2030_	645
I	24 x 20 x 29	600 x 500 x 735	QS41NN-DT2024_	605
Specify panel legs (A, B, C).				

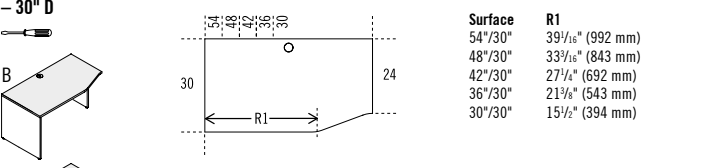
	W x D x H (in)	W x D x H (mm)	Code	Price (\$)
Asymmetrical tables – 30" D	<i>Full-height modesty panel. 1 grommet.</i>			
			Surface 54"/30" 48"/30" 42"/30" 36"/30" 30"/30"	R1 39 9/16" (992 mm) 33 3/16" (843 mm) 27 1/4" (692 mm) 21 1/8" (543 mm) 15 1/2" (394 mm)
B	54 x 30 x 29	1350 x 750 x 735	QS41NN-AT305424_	926
C	48 x 30 x 29	1200 x 750 x 735	QS41NN-AT304824_	885
D	42 x 30 x 29	1050 x 750 x 735	QS41NN-AT304224_	847
E	36 x 30 x 29	900 x 750 x 735	QS41NN-AT303624_	805
F	30 x 30 x 29	750 x 750 x 735	QS41NN-AT303024_	766
Specify panel legs (B, C).				

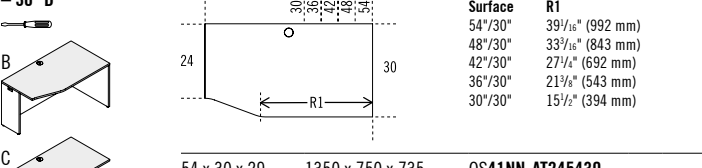
	W x D x H (in)	W x D x H (mm)	Code	Price (\$)
Asymmetrical tables – 30" D	<i>Full-height modesty panel. 1 grommet.</i>			
			Surface 54"/30" 48"/30" 42"/30" 36"/30" 30"/30"	R1 39 9/16" (992 mm) 33 3/16" (843 mm) 27 1/4" (692 mm) 21 1/8" (543 mm) 15 1/2" (394 mm)
B	54 x 30 x 29	1350 x 750 x 735	QS41NN-AT245430_	926
C	48 x 30 x 29	1200 x 750 x 735	QS41NN-AT244830_	885
D	42 x 30 x 29	1050 x 750 x 735	QS41NN-AT244230_	847
E	36 x 30 x 29	900 x 750 x 735	QS41NN-AT243630_	805
F	30 x 30 x 29	750 x 750 x 735	QS41NN-AT243030_	766
Specify panel legs (B, C).				

 = ASSEMBLY REQUIRED

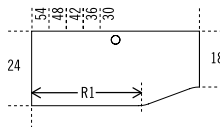
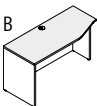
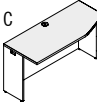
	W x D x H (in)	W x D x H (mm)	Code	Price (\$)
Asymmetrical tables - 24" D	<i>Full-height modesty panel. 1 grommet.</i>			
			Surface R1	
			54"/24" 39 1/16" (992 mm)	
			48"/24" 33 3/16" (843 mm)	
			42"/24" 27 1/4" (692 mm)	
			36"/24" 21 1/8" (543 mm)	
			30"/24" 15 1/2" (394 mm)	
	54 x 24 x 29	1350 x 600 x 735	QS41NN-AT245418	896
	48 x 24 x 29	1200 x 600 x 735	QS41NN-AT244818	856
	42 x 24 x 29	1050 x 600 x 735	QS41NN-AT244218	813
	36 x 24 x 29	900 x 600 x 735	QS41NN-AT243618	773
	30 x 24 x 29	750 x 600 x 735	QS41NN-AT243018	731

Specify panel legs (B, C).

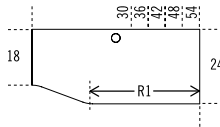
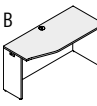
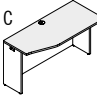
	W x D x H (in)	W x D x H (mm)	Code	Price (\$)
Asymmetrical tables - 24" D	<i>Full-height modesty panel. 1 grommet.</i>			
			Surface R1	
			54"/24" 39 1/16" (992 mm)	
			48"/24" 33 3/16" (843 mm)	
			42"/24" 27 1/4" (692 mm)	
			36"/24" 21 1/8" (543 mm)	
			30"/24" 15 1/2" (394 mm)	
	54 x 24 x 29	1350 x 600 x 735	QS41NN-AT185424	896
	48 x 24 x 29	1200 x 600 x 735	QS41NN-AT184824	856
	42 x 24 x 29	1050 x 600 x 735	QS41NN-AT184224	813
	36 x 24 x 29	900 x 600 x 735	QS41NN-AT183624	773
	30 x 24 x 29	750 x 600 x 735	QS41NN-AT183024	731

Specify panel legs (B, C).

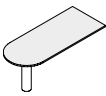
	W x D x H (in)	W x D x H (mm)	Code	Price (\$)
D-shaped surfaces	<i>Black steel leg. Must be attached to a work surface. Order LGC-BAR for any surface wider than 60", refer to the Lacasse general price book.</i>			
	72 x 36 x 29	1800 x 900 x 735	QS41NN-BU3672	998
	72 x 30 x 29	1800 x 750 x 735	QS41NN-BU3072	918
	66 x 30 x 29	1650 x 750 x 735	QS41NN-BU3066	870
	60 x 30 x 29	1500 x 750 x 735	QS41NN-BU3060	831
	66 x 24 x 29	1650 x 600 x 735	QS41NN-BU2466	798
	60 x 24 x 29	1500 x 600 x 735	QS41NN-BU2460	742
	48 x 24 x 29	1200 x 600 x 735	QS41NN-BU2448	701

Packaged in 2 boxes.

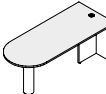
	W x D x H (in)	W x D x H (mm)	Code	Price (\$)
D-shaped surfaces	<i>Black steel leg. 1 grommet. Must be attached to a work surface.</i>			
	72 x 36 x 29	1800 x 900 x 735	QS41NN-BT3672	1,152
	72 x 30 x 29	1800 x 750 x 735	QS41NN-BT3072	1,088
	66 x 30 x 29	1650 x 750 x 735	QS41NN-BT3066	1,041
	60 x 30 x 29	1500 x 750 x 735	QS41NN-BT3060	998
	66 x 24 x 29	1650 x 600 x 735	QS41NN-BT2466	960
	60 x 24 x 29	1500 x 600 x 735	QS41NN-BT2460	902
	48 x 24 x 29	1200 x 600 x 735	QS41NN-BT2448	862

Packaged in 2 boxes.

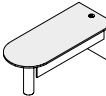
	W x D x H (in)	W x D x H (mm)	Code	Price (\$)
D-shaped surfaces	<i>Reversible modesty panel. Black steel leg. 1 grommet. Must be attached to another surface. Packaged in 2 boxes.</i>			
	72 x 36 x 29	1800 x 900 x 735	QS41NN-BTM3672	1,298
	72 x 30 x 29	1800 x 750 x 735	QS41NN-BTM3072	1,219
	66 x 30 x 29	1650 x 750 x 735	QS41NN-BTM3066	1,169
	60 x 30 x 29	1500 x 750 x 735	QS41NN-BTM3060	1,119

	W x D x H (in)	W x D x H (mm)	Code	Price (\$)
Left P-shaped surfaces	<i>Black steel leg. 1 grommet. Must be attached to another surface. Packaged in 2 boxes.</i>			
	72 x 42 x 29	1800 x 1050 x 735	QS41NN-PT3072	1,306
	66 x 42 x 29	1650 x 1050 x 735	QS41NN-PT3066	1,274
	60 x 42 x 29	1500 x 1050 x 735	QS41NN-PT3060	1,232

	W x D x H (in)	W x D x H (mm)	Code	Price (\$)
Right P-shaped surfaces	<i>Black steel leg. 1 grommet. Must be attached to another surface. Packaged in 2 boxes.</i>			
	72 x 42 x 29	1800 x 1050 x 735	QS41NN-3072PT	1,306
	66 x 42 x 29	1650 x 1050 x 735	QS41NN-3066PT	1,274
	60 x 42 x 29	1500 x 1050 x 735	QS41NN-3060PT	1,232

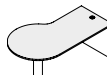
	W x D x H (in)	W x D x H (mm)	Code	Price (\$)
Left P-shaped surfaces	<i>Modesty panel. Black steel leg. 1 grommet. Must be attached to another surface. Packaged in 2 boxes.</i>			
	72 x 42 x 29	1800 x 1050 x 735	QS41NN-PTM3072	1,384
	66 x 42 x 29	1650 x 1050 x 735	QS41NN-PTM3066	1,355
	60 x 42 x 29	1500 x 1050 x 735	QS41NN-PTM3060	1,322

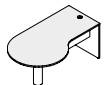
	W x D x H (in)	W x D x H (mm)	Code	Price (\$)
Right P-shaped surfaces	<i>Modesty panel. Black steel leg. 1 grommet. Must be attached to another surface. Packaged in 2 boxes.</i>			
	72 x 42 x 29	1800 x 1050 x 735	QS41NN-3072PTM	1,384
	66 x 42 x 29	1650 x 1050 x 735	QS41NN-3066PTM	1,355
	60 x 42 x 29	1500 x 1050 x 735	QS41NN-3060PTM	1,322

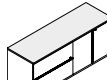
	W x D x H (in)	W x D x H (mm)	Code	Price (\$)
Lateral file / bookcase credenzas	<i>2 file drawers with suspension bars. Bookcase unit with doors and adjustable shelf. Locks.</i>			
	72 x 24 x 29	1800 x 600 x 735	QS41_N-LF2472B	2,410
	72 x 20 x 29	1800 x 500 x 735	QS41_N-LF2072B	2,241

Specify the handle code (X, Y, L).

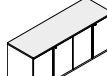
	W x D x H (in)	W x D x H (mm)	Code	Price (\$)
Bookcase credenzas	<i>Storage unit with doors and adjustable shelves. Locks.</i>			
	72 x 24 x 29	1800 x 600 x 735	QS41_N-B2472B	2,184
	72 x 20 x 29	1800 x 500 x 735	QS41_N-B2072B	2,014

Specify the handle code (X, Y, L).

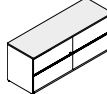
	W x D x H (in)	W x D x H (mm)	Code	Price (\$)
Lateral file credenzas	<i>4 file drawers with suspension bars. Locks. Optional counterweights to meet BIFMA standards, refer to the Lacasse general price book.</i>			
	72 x 24 x 29	1800 x 600 x 735	QS41_N-LF2472LF	2,662
	72 x 20 x 29	1800 x 500 x 735	QS41_N-LF2072LF	2,491

Specify the handle code (X, Y, L).

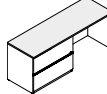
	W x D x H (in)	W x D x H (mm)	Code	Price (\$)
Left lateral file credenzas	<i>2 file drawers on left with suspension bars. Lock. Grommet on back.</i>			
	72 x 24 x 29	1800 x 600 x 735	QS41_N-LF2472S	1,988
	66 x 24 x 29	1650 x 600 x 735	QS41_N-LF2466S	1,910
	60 x 24 x 29	1500 x 600 x 735	QS41_N-LF2460S	1,829
	72 x 20 x 29	1800 x 500 x 735	QS41_N-LF2072S	1,829
	66 x 20 x 29	1650 x 500 x 735	QS41_N-LF2066S	1,738
	60 x 20 x 29	1500 x 500 x 735	QS41_N-LF2060S	1,702

Specify the handle code (X, Y, L).

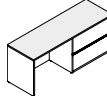
	W x D x H (in)	W x D x H (mm)	Code	Price (\$)
Right lateral file credenzas	<i>2 file drawers on left with suspension bars. Lock. Grommet on back.</i>			
	72 x 24 x 29	1800 x 600 x 735	QS41_N-S2472LF	1,988
	66 x 24 x 29	1650 x 600 x 735	QS41_N-S2466LF	1,910
	60 x 24 x 29	1500 x 600 x 735	QS41_N-S2460LF	1,829
	72 x 20 x 29	1800 x 500 x 735	QS41_N-S2072LF	1,829
	66 x 20 x 29	1650 x 500 x 735	QS41_N-S2066LF	1,738
	60 x 20 x 29	1500 x 500 x 735	QS41_N-S2060LF	1,702

Specify the handle code (X, Y, L).

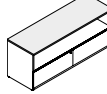
	W x D x H (in)	W x D x H (mm)	Code	Price (\$)
Lateral file credenzas	<i>Open space on top and 2 file drawers on bottom with suspension bars. Locks. Grommet on back. Optional counterweights to meet BIFMA standards, refer to the Lacasse general price book.</i>			
	72 x 24 x 29	1800 x 600 x 735	QS41_N-SLF2472	1,926
	72 x 20 x 29	1800 x 500 x 735	QS41_N-SLF2072	1,738

Specify the handle code (X, Y, L).

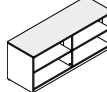
	W x D x H (in)	W x D x H (mm)	Code	Price (\$)
Open bookcase credenzas	<i>1 adjustable shelf on each side.</i>			
	72 x 24 x 29	1800 x 600 x 735	QS41NN-BE2472BE	1,669
	72 x 20 x 29	1800 x 500 x 735	QS41NN-BE2072BE	1,585

 = ASSEMBLY REQUIRED

	W x D x H (in)	W x D x H (mm)	Code	Price (\$)
Left open bookcase credenzas	<i>Adjustable shelf. Full-height modesty panel. Grommet on back.</i>			
	72 x 24 x 29	1800 x 600 x 735	QS41NN-BE2472S	1,538
	72 x 20 x 29	1800 x 500 x 735	QS41NN-BE2072S	1,452

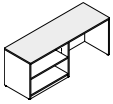

	W x D x H (in)	W x D x H (mm)	Code	Price (\$)
Right open bookcase credenzas	<i>Adjustable shelf. Full-height modesty panel. Grommet on back.</i>			
	72 x 24 x 29	1800 x 600 x 735	QS41NN-S2472BE	1,538
	72 x 20 x 29	1800 x 500 x 735	QS41NN-S2072BE	1,452

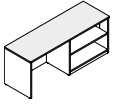

	W x D x H (in)	W x D x H (mm)	Code	Price (\$)
Right open bookcase credenzas	<i>2 pedestals with locks, 2 box drawers and 2 file drawers with suspension bars. Pencil tray. Grommet on back.</i>			
	72 x 24 x 29	1800 x 600 x 735	QS41_N-F2472F	1,910
	66 x 24 x 29	1650 x 600 x 735	QS41_N-F2466F	1,877
	60 x 24 x 29	1500 x 600 x 735	QS41_N-F2460F	1,847
	72 x 20 x 29	1800 x 500 x 735	QS41_N-F2072F	1,738
	66 x 20 x 29	1650 x 500 x 735	QS41_N-F2066F	1,709
	60 x 20 x 29	1500 x 500 x 735	QS41_N-F2060F	1,676
	<i>2 full-height pedestals option.</i>			
	72 x 24 x 29	1800 x 600 x 735	QS41_N-UF2472FF	2,312
	66 x 24 x 29	1650 x 600 x 735	QS41_N-UF2466FF	2,278
60 x 24 x 29	1500 x 600 x 735	QS41_N-UF2460FF	2,246	
72 x 20 x 29	1800 x 500 x 735	QS41_N-UF2072FF	2,138	
66 x 20 x 29	1650 x 500 x 735	QS41_N-UF2066FF	2,110	
60 x 20 x 29	1500 x 500 x 735	QS41_N-UF2060FF	2,078	

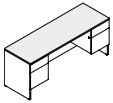

Specify the handle code (X, Y, N).

	W x D x H (in)	W x D x H (mm)	Code	Price (\$)
Left single pedestal credenzas	<i>1 pedestal on left with lock, 1 box drawer and 1 file drawer with suspension bar. Pencil tray. Grommet on back.</i>			
	72 x 24 x 29	1800 x 600 x 735	QS41_N-F2472S	1,459
	66 x 24 x 29	1650 x 600 x 735	QS41_N-F2466S	1,426
	60 x 24 x 29	1500 x 600 x 735	QS41_N-F2460S	1,395
	72 x 20 x 29	1800 x 500 x 735	QS41_N-F2072S	1,357
	66 x 20 x 29	1650 x 500 x 735	QS41_N-F2066S	1,328
	60 x 20 x 29	1500 x 500 x 735	QS41_N-F2060S	1,298
	<i>Full-height pedestal option.</i>			
	72 x 24 x 29	1800 x 600 x 735	QS41_N-UF2472S	1,660
	66 x 24 x 29	1650 x 600 x 735	QS41_N-UF2466S	1,627
60 x 24 x 29	1500 x 600 x 735	QS41_N-UF2460S	1,596	
72 x 20 x 29	1800 x 500 x 735	QS41_N-UF2072S	1,557	
66 x 20 x 29	1650 x 500 x 735	QS41_N-UF2066S	1,528	
60 x 20 x 29	1500 x 500 x 735	QS41_N-UF2060S	1,499	

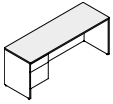

Specify the handle code (X, Y, N).

	W x D x H (in)	W x D x H (mm)	Code	Price (\$)
Right single pedestal credenzas	<i>1 pedestal on right with lock, 1 box drawer and 1 file drawer with suspension bar. Pencil tray. Grommet on back.</i>			
	72 x 24 x 29	1800 x 600 x 735	QS41_N-S2472F	1,459
	66 x 24 x 29	1650 x 600 x 735	QS41_N-S2466F	1,426
	60 x 24 x 29	1500 x 600 x 735	QS41_N-S2460F	1,395
	72 x 20 x 29	1800 x 500 x 735	QS41_N-S2072F	1,357
	66 x 20 x 29	1650 x 500 x 735	QS41_N-S2066F	1,328
	60 x 20 x 29	1500 x 500 x 735	QS41_N-S2060F	1,298
	<i>Full-height pedestal option.</i>			
	72 x 24 x 29	1800 x 600 x 735	QS41_N-S2472UF	1,660
	66 x 24 x 29	1650 x 600 x 735	QS41_N-S2466UF	1,627
60 x 24 x 29	1500 x 600 x 735	QS41_N-S2460UF	1,596	
72 x 20 x 29	1800 x 500 x 735	QS41_N-S2072UF	1,557	
66 x 20 x 29	1650 x 500 x 735	QS41_N-S2066UF	1,528	
60 x 20 x 29	1500 x 500 x 735	QS41_N-S2060UF	1,499	

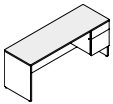

Specify the handle code (X, Y, N).

	W x D x H (in)	W x D x H (mm)	Code	Price (\$)
Bridge-returns	<i>Full-height modesty panel. 1 grommet.</i>			
	48 x 24 x 29	1200 x 600 x 735	QS41NN-BR2448	540
	42 x 24 x 29	1050 x 600 x 735	QS41NN-BR2442	510
	36 x 24 x 29	900 x 600 x 735	QS41NN-BR2436	476
	48 x 20 x 29	1200 x 500 x 735	QS41NN-BR2048	490
	42 x 20 x 29	1050 x 500 x 735	QS41NN-BR2042	459
	36 x 20 x 29	900 x 500 x 735	QS41NN-BR2036	427

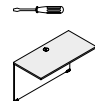

	W x D x H (in)	W x D x H (mm)	Code	Price (\$)
Return shells	<i>Reversible. 1 grommet. Can accommodate 1 pedestal.</i>			
	48 x 24 x 29	1200 x 600 x 735	QS41NN-R2448S	620
	42 x 24 x 29	1050 x 600 x 735	QS41NN-R2442S	580
	48 x 20 x 29	1200 x 500 x 735	QS41NN-R2048S	563
	42 x 20 x 29	1050 x 500 x 735	QS41NN-R2042S	525

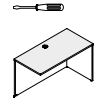

	W x D x H (in)	W x D x H (mm)	Code	Price (\$)
Left executive returns	<i>1 pedestal on left with lock, 1 box drawer and 1 file drawer with suspension bar. Pencil tray. 1 grommet.</i>			
	48 x 24 x 29	1200 x 600 x 735	QS41_N-F2448R	1,193
	42 x 24 x 29	1050 x 600 x 735	QS41_N-F2442R	1,127
	48 x 20 x 29	1200 x 500 x 735	QS41_N-F2048R	1,138
	42 x 20 x 29	1050 x 500 x 735	QS41_N-F2042R	1,102
	<i>Full-height pedestal option.</i>			
	48 x 24 x 29	1200 x 600 x 735	QS41_N-UF2448R	1,394
	42 x 24 x 29	1050 x 600 x 735	QS41_N-UF2442R	1,329
	48 x 20 x 29	1200 x 500 x 735	QS41_N-UF2048R	1,337
	42 x 20 x 29	1050 x 500 x 735	QS41_N-UF2042R	1,304



Specify the handle code (X, Y, N).

	W x D x H (in)	W x D x H (mm)	Code	Price (\$)
Right executive returns	<i>1 pedestal on right with lock, 1 box drawer and 1 file drawer with suspension bar. Pencil tray. 1 grommet.</i>			
	48 x 24 x 29	1200 x 600 x 735	QS41_N-R2448F	1,193
	42 x 24 x 29	1050 x 600 x 735	QS41_N-R2442F	1,127
	48 x 20 x 29	1200 x 500 x 735	QS41_N-R2048F	1,138
	42 x 20 x 29	1050 x 500 x 735	QS41_N-R2042F	1,102
	<i>Full-height pedestal option.</i>			
	48 x 24 x 29	1200 x 600 x 735	QS41_N-R2448UF	1,394
	42 x 24 x 29	1050 x 600 x 735	QS41_N-R2442UF	1,329
	48 x 20 x 29	1200 x 500 x 735	QS41_N-R2048UF	1,337
	42 x 20 x 29	1050 x 500 x 735	QS41_N-R2042UF	1,304



Specify the handle code (X, Y, N).

	W x D x H (in)	W x D x H (mm)	Code	Price (\$)
Hutches with doors - 44" H	<i>Clearance: 21½". Grommet. Full-width wire access. Can accommodate a tackboard, refer to the Lacasse general price book.</i>			
	84 x 16 x 44	2100 x 400 x 1099	QS41NN-E844416P	1,910
	78 x 16 x 44	1950 x 400 x 1099	QS41NN-E784416P	1,829
	72 x 16 x 44	1800 x 400 x 1099	QS41NN-E724416P	1,738
	66 x 16 x 44	1650 x 400 x 1099	QS41NN-E664416P	1,660
	60 x 16 x 44	1500 x 400 x 1099	QS41NN-E604416P	1,578
	54 x 16 x 44	1350 x 400 x 1099	QS41NN-E544416P	1,490
	48 x 16 x 44	1200 x 400 x 1099	QS41NN-E484416P	1,411
	42 x 16 x 44	1050 x 400 x 1099	QS41NN-E424416P	1,329
	36 x 16 x 44	900 x 400 x 1099	QS41NN-E364416P	1,249

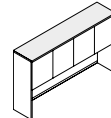



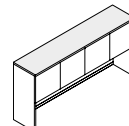

84" to 60": 4 doors
54" to 48": 3 doors
42" to 36": 2 doors

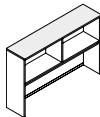

	W x D x H (in)	W x D x H (mm)	Code	Price (\$)
Hutches with doors - 36" H	<i>Clearance: 17⅝". Grommet. Full-width wire access. Can accommodate a tackboard, refer to the Lacasse general price book.</i>			
	84 x 16 x 36	2100 x 400 x 900	QS41NN-E843616P	1,738
	78 x 16 x 36	1950 x 400 x 900	QS41NN-E783616P	1,660
	72 x 16 x 36	1800 x 400 x 900	QS41NN-E723616P	1,578
	66 x 16 x 36	1650 x 400 x 900	QS41NN-E663616P	1,490
	60 x 16 x 36	1500 x 400 x 900	QS41NN-E603616P	1,411
	54 x 16 x 36	1350 x 400 x 900	QS41NN-E543616P	1,329
	48 x 16 x 36	1200 x 400 x 900	QS41NN-E483616P	1,249
	42 x 16 x 36	1050 x 400 x 900	QS41NN-E423616P	1,161
	36 x 16 x 36	900 x 400 x 900	QS41NN-E363616P	1,080



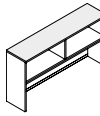

84" to 60": 4 doors
54" to 48": 3 doors
42" to 36": 2 doors

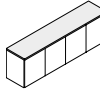
	W x D x H (in)	W x D x H (mm)	Code	Price (\$)
Open hutches – 44" H	<i>Clearance: 21 1/2". Grommet. Full-width wire access. Can accommodate a tackboard, refer to the Lacasse general price book.</i>			
	84 x 16 x 44	2100 x 400 x 1099	QS41NN-E844416	1,578
	78 x 16 x 44	1950 x 400 x 1099	QS41NN-E784416	1,490
	72 x 16 x 44	1800 x 400 x 1099	QS41NN-E724416	1,411
	66 x 16 x 44	1650 x 400 x 1099	QS41NN-E664416	1,329
	60 x 16 x 44	1500 x 400 x 1099	QS41NN-E604416	1,249
	54 x 16 x 44	1350 x 400 x 1099	QS41NN-E544416	1,161
	48 x 16 x 44	1200 x 400 x 1099	QS41NN-E484416	1,080
	42 x 16 x 44	1050 x 400 x 1099	QS41NN-E424416	998
	36 x 16 x 44	900 x 400 x 1099	QS41NN-E364416	912

	W x D x H (in)	W x D x H (mm)	Code	Price (\$)
Open hutches – 36" H	<i>Clearance: 17 5/8". Grommet. Full-width wire access. Can accommodate a tackboard, refer to the Lacasse general price book.</i>			
	84 x 16 x 36	2100 x 400 x 900	QS41NN-E843616	1,411
	78 x 16 x 36	1950 x 400 x 900	QS41NN-E783616	1,329
	72 x 16 x 36	1800 x 400 x 900	QS41NN-E723616	1,249
	66 x 16 x 36	1650 x 400 x 900	QS41NN-E663616	1,161
	60 x 16 x 36	1500 x 400 x 900	QS41NN-E603616	1,080
	54 x 16 x 36	1350 x 400 x 900	QS41NN-E543616	998
	48 x 16 x 36	1200 x 400 x 900	QS41NN-E483616	912
	42 x 16 x 36	1050 x 400 x 900	QS41NN-E423616	831
	36 x 16 x 36	900 x 400 x 900	QS41NN-E363616	752

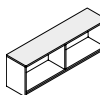
	W x D x H (in)	W x D x H (mm)	Code	Price (\$)
Wall-mounted hutches with doors – 22" H	<i>Hanger bar included for wall-mount installation. Can accommodate a tackboard, refer to the Lacasse general price book.</i>			
	84 x 16 x 22	2100 x 400 x 553	QS41NN-EM842216P	1,780
	78 x 16 x 22	1950 x 400 x 553	QS41NN-EM782216P	1,702
	72 x 16 x 22	1800 x 400 x 553	QS41NN-EM722216P	1,621
	66 x 16 x 22	1650 x 400 x 553	QS41NN-EM662216P	1,538
	60 x 16 x 22	1500 x 400 x 553	QS41NN-EM602216P	1,452
	54 x 16 x 22	1350 x 400 x 553	QS41NN-EM542216P	1,371
	48 x 16 x 22	1200 x 400 x 553	QS41NN-EM482216P	1,289
	42 x 16 x 22	1050 x 400 x 553	QS41NN-EM422216P	1,201
	36 x 16 x 22	900 x 400 x 553	QS41NN-EM362216P	1,119

	W x D x H (in)	W x D x H (mm)	Code	Price (\$)
Wall-mounted open hutches – 22" H	<i>Hanger bar included for wall-mount installation. Can accommodate a tackboard, refer to the Lacasse general price book.</i>			
	84 x 16 x 22	2100 x 400 x 553	QS41NN-EM842216	1,452
	78 x 16 x 22	1950 x 400 x 553	QS41NN-EM782216	1,371
	72 x 16 x 22	1800 x 400 x 553	QS41NN-EM722216	1,289
	66 x 16 x 22	1650 x 400 x 553	QS41NN-EM662216	1,201
	60 x 16 x 22	1500 x 400 x 553	QS41NN-EM602216	1,119
	54 x 16 x 22	1350 x 400 x 553	QS41NN-EM542216	1,041
	48 x 16 x 22	1200 x 400 x 553	QS41NN-EM482216	951
	42 x 16 x 22	1050 x 400 x 553	QS41NN-EM422216	870
	36 x 16 x 22	900 x 400 x 553	QS41NN-EM362216	791

	W x D x H (in)	W x D x H (mm)	Code	Price (\$)
Lateral file units	<i>2 file drawers with suspension bars. Lock. Optional counterweight to meet BIFMA standards, refer to the Lacasse general price book.</i>			
	36 x 24 x 29	900 x 600 x 735	QS41_N-2436LF	1,452
	30 x 24 x 29	750 x 600 x 735	QS41_N-2430LF	1,384
	36 x 20 x 29	900 x 500 x 735	QS41_N-2036LF	1,395
	30 x 20 x 29	750 x 500 x 735	QS41_N-2030LF	1,329
	Specify the handle code (X, Y, L).			

	W x D x H (in)	W x D x H (mm)	Code	Price (\$)
Bookcase units with doors	<i>Adjustable shelf. Lock.</i>			
	36 x 24 x 29	900 x 600 x 735	QS41_N-2436B	1,249
	30 x 24 x 29	750 x 600 x 735	QS41_N-2430B	1,176
	36 x 20 x 29	900 x 500 x 735	QS41_N-2036B	1,193
	30 x 20 x 29	750 x 500 x 735	QS41_N-2030B	1,127
	Specify the handle code (X, Y, L).			

	W x D x H (in)	W x D x H (mm)	Code	Price (\$)
Combined pedestals	<i>2 box drawers on left, 2 file drawers with suspension bars. Lock. Pencil tray.</i>			
	36 x 24 x 29	900 x 600 x 735	QS41_N-2436CO	1,732
	36 x 20 x 29	900 x 500 x 735	QS41_N-2036CO	1,684
	Specify the handle code (X, Y, L).			

	W x D x H (in)	W x D x H (mm)	Code	Price (\$)
Combined pedestals	<i>2 box drawers on right, 2 file drawers with suspension bars. Lock. Pencil tray.</i>			
	36 x 24 x 29	900 x 600 x 735	QS41_N-C02436	1,732
	36 x 20 x 29	900 x 500 x 735	QS41_N-C02036	1,684
	Specify the handle code (X, Y, L).			

	W x D x H (in)	W x D x H (mm)	Code	Price (\$)
Modular lateral files	<i>2 file drawers with suspension bars. Lock. Must be installed under a work surface. 1 tone only.</i>			
	36 x 18 x 28	898 x 448 x 711	QS4N_N-1836LFL	1,289
	30 x 18 x 28	748 x 448 x 711	QS4N_N-1830LFL	1,219
	Specify the handle code (X, Y, L).			

	W x D x H (in)	W x D x H (mm)	Code	Price (\$)
Modular combined pedestal	<i>2 box drawers on left, 2 file drawers with suspension bars. Lock. Pencil tray. Must be installed under a work surface. 1 tone only.</i>			
	36 x 18 x 28	898 x 448 x 711	QS4N_N-1836COL	1,654
	Specify the handle code (X, Y, L).			









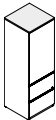

	W x D x H (in)	W x D x H (mm)	Code	Price (\$)
Modular combined pedestal	<i>2 box drawers on right, 2 file drawers with suspension bars. Lock. Pencil tray. Must be installed under a work surface. 1 tone only.</i>			
	36 x 18 x 28	898 x 448 x 711	QS4N_N-C01836L	1,654
	Specify the handle code (X, Y, L).			

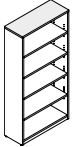
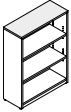







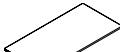

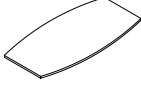

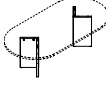
	W x D x H (in)	W x D x H (mm)	Code	Price (\$)
Storage or wardrobe units	<i>Adjustable shelf. Lock. Must be installed under a work surface. 1 tone only.</i>			
	36 x 18 x 28	898 x 448 x 711	QS4N_N-1836BL	1,161
	30 x 18 x 28	748 x 448 x 711	QS4N_N-1830BL	1,096
	Specify the handle code (X, Y, L).			

	W x D x H (in)	W x D x H (mm)	Code	Price (\$)
Storage or wardrobe units	<i>3 adjustable shelves and 1 full-width fixed shelf. Full-width clothes hanger bar. 73" H storage unit matches the height of a credenza with a 44" H hutch. 65" H storage unit matches the height of a credenza with a 36" H hutch.</i>			
	36 x 24 x 73	900 x 600 x 1834	QS41_N-243673B	2,199
	36 x 20 x 73	900 x 500 x 1834	QS41_N-203673B	2,029
	36 x 24 x 65	900 x 600 x 1635	QS41_N-243665B	2,029
	36 x 20 x 65	900 x 500 x 1635	QS41_N-203665B	1,869
	Specify the handle code (X, Y, L).			

	W x D x H (in)	W x D x H (mm)	Code	Price (\$)
Storage units with lateral file	<i>3 adjustable shelves and 1 full-width fixed shelf. Full-width clothes hanger bar. 73" H storage unit matches the height of a credenza with a 44" H hutch. 65" H storage unit matches the height of a credenza with a 36" H hutch.</i>			
	24 x 24 x 73	600 x 600 x 1834	QS41_N-242473BR	1,780
	24 x 24 x 73	600 x 600 x 1834	QS41_N-242473BL	1,780
	24 x 20 x 73	600 x 500 x 1834	QS41_N-202473BR	1,702
	24 x 20 x 73	600 x 500 x 1834	QS41_N-202473BL	1,702
	24 x 24 x 65	600 x 600 x 1635	QS41_N-242465BR	1,702
	24 x 24 x 65	600 x 600 x 1635	QS41_N-242465BL	1,702
	24 x 20 x 65	600 x 500 x 1635	QS41_N-202465BR	1,621
	24 x 20 x 65	600 x 500 x 1635	QS41_N-202465BL	1,621
	Specify the handle code (X, Y, L).			

	W x D x H (in)	W x D x H (mm)	Code	Price (\$)
Storage units with lateral file	<i>2 adjustable shelves. 2 file drawers with suspension bars. Lock on drawers. 73" H storage matches the height of a credenza with a 44" H hutch. 65" H storage unit matches the height of a credenza with a 36" H hutch.</i>			
	36 x 24 x 73	900 x 600 x 1834	QS41_N-243673LFB	2,662
	36 x 20 x 73	900 x 500 x 1834	QS41_N-203673LFB	2,491
	36 x 24 x 65	900 x 600 x 1635	QS41_N-243665LFB	2,551
	36 x 20 x 65	900 x 500 x 1635	QS41_N-203665LFB	2,393
	Specify the handle code (X, Y, L).			

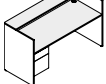
	W x D x H (in)	W x D x H (mm)	Code	Price (\$)
Storage units with lateral file  Open right (FBR)  Open left (FBL)	<i>Reversible door. 2 adjustable shelves. 2 file drawers with suspension bars. Lock on drawers. 73" H storage unit matches the height of a credenza with a 44" H hutch. 65" H storage unit matches the height of a credenza with a 36" H hutch.</i>			
	24 x 24 x 73	600 x 600 x 1834	QS41_N-242473FBR	2,257
	24 x 24 x 73	600 x 600 x 1834	QS41_N-242473FBL	2,257
	24 x 20 x 73	600 x 500 x 1834	QS41_N-202473FBR	2,095
	24 x 20 x 73	600 x 600 x 1834	QS41_N-202473FBL	2,095
	24 x 24 x 65	600 x 600 x 1635	QS41_N-242465FBR	2,175
	24 x 24 x 65	600 x 600 x 1635	QS41_N-242465FBL	2,175
	24 x 20 x 65	600 x 500 x 1635	QS41_N-202465FBR	2,008
	24 x 20 x 65	600 x 600 x 1635	QS41_N-202465FBL	2,008
	Specify the handle code (X, Y, L).			
Open bookcases  	<i>4 adjustable shelves.</i>			
	36 x 14 x 73	900 x 350 x 1834	QS41NN-B367314	1,249
	36 x 14 x 65	900 x 350 x 1635	QS41NN-B366514	1,119
	<i>2 adjustable shelves.</i>			
	36 x 14 x 48	900 x 350 x 1200	QS41NN-B364814	998
<i>Additional shelf.</i>				
34 x 13 x 1	846 x 325 x 25	QS41NN-TB3614.1E	168	
Mobile pedestals 	<i>2 box drawers, 1 file drawer with suspension bar. Pencil tray. Brakes on front casters. Lock. Fits under a work surface. 1 tone only.</i>			
	15 x 23 x 27 1/8	390 x 575 x 689	QS4N_N-MP1523UF	1,219
	15 x 18 x 27 1/8	390 x 450 x 689	QS4N_N-MP1518UF	1,138
Specify the handle code (X, Y, L).				
Mobile pedestal 	<i>2 file drawers with suspension bars. Brakes on front casters. Lock. Fits under a work surface. 1 tone only.</i>			
	15 x 23 x 27 1/8	390 x 575 x 689	QS4N_N-MP1523FF	1,161
Specify the handle code (X, Y, L).				
Mobile pedestals 	<i>1 box drawer and 1 file drawer with suspension bar. Pencil tray. Brakes on front casters. Lock. Fits under a work surface. 1 tone only.</i>			
	15 x 23 x 20 3/4	390 x 575 x 527	QS4N_N-MP1523F	1,119
	15 x 18 x 20 3/4	390 x 450 x 527	QS4N_N-MP1518F	1,080
Specify the handle code (X, Y, L).				
Modular pedestal 	<i>2 box drawers, 1 file drawer with suspension bar. Pencil tray. Lock. Must be installed under work surface. 1 tone only.</i>			
	15 x 18 x 28	388 x 448 x 711	QS4N_N-P1518UFL	1,054
Specify the handle code (X, Y, L).				
Modular pedestal 	<i>2 file drawers with suspension bars. Lock. Must be installed under a work surface. 1 tone only.</i>			
	15 x 18 x 28	388 x 448 x 711	QS4N_N-P1518FFL	1,015
Specify the handle code (X, Y, L).				
Hanging pedestal 	<i>1 box drawer and 1 file drawer with suspension bar. Pencil tray. Lock. Must be installed under a work surface de travail. 1 tone only.</i>			
	15 x 17 1/2 x 19 1/4	388 x 448 x 489	QS4N_N-F	926
Specify the handle code (X, Y, L).				
Round tops 	<i>Conference tables.</i>			
	36 x 36 x 1 1/2	900 x 900 x 38	QS45NN-R36	498
	42 x 42 x 1 1/2	1050 x 1050 x 38	QS45NN-R42	686
	48 x 48 x 1 1/2	1200 x 1200 x 38	QS45NN-R48	758
Rectangular tops 	<i>Conference tables.</i>			
	72 x 36 x 1 1/2	1800 x 900 x 38	QS45NN-REC72	839
	96 x 48 x 1 1/2	2400 x 1200 x 38	QS45NN-REC96	1,201

	W x D x H (in)	W x D x H (mm)	Code	Price (\$)
Boat-shape tops 	<i>Conference tables. 120" and 144" tops are in two pieces.</i>			
	96 x 48 x 1 1/2	2400 x 1200 x 38	QS45NN-B96	1,335
	120 x 48 x 1 1/2	3000 x 1200 x 38	QS45NN-B120	1,676
	144 x 48 x 1 1/2	3600 x 1200 x 38	QS45NN-B144	1,760
Racetrack tops 	<i>Conference tables. 120" and 144" tops are in two pieces.</i>			
	72 x 36 x 1 1/2	1800 x 900 x 38	QS45NN-RT72	973
	96 x 48 x 1 1/2	2400 x 1200 x 38	QS45NN-RT96	1,335
	120 x 48 x 1 1/2	3000 x 1200 x 38	QS45NN-RT120	1,676
	144 x 48 x 1 1/2	3600 x 1200 x 38	QS45NN-RT144	1,760
Cross bases 	<i>1 1/2" thermofused laminate.</i>			
	22 x 22 x 28	555 x 555 x 710	QSLGC-CR22	532
	27 x 27 x 28	680 x 680 x 710	QSLGC-CR27	590
	33 x 33 x 28	825 x 825 x 710	QSLGC-CR33	669
V-bases 	<i>1 1/2" thermofused laminate.</i>			
	18 x 18 x 28	450 x 450 x 710	QSLGC-2V18	(pair) 849
Leg 	<i>Black steel leg.</i>			
	6 x 6 x 28	150 x 150 x 710	QSLGC-TL NNN	(each) 396
Printer table 	<i>1 height adjustable sliding shelf. Grommet on modesty panel.</i>			
	30 x 24 x 29	750 x 600 x 735	QS41NN-2430PS	998
Coffee table 	<i>22 x 22 x 18</i>			
	22 x 22 x 18	550 x 550 x 450	QS41NN-ST222218	540
Magazine table 	<i>48 x 22 x 18</i>			
	48 x 22 x 18	1200 x 550 x 450	QS41NN-ST224818	580
Mobile serving carts  	<i>1 sliding shelf, 1 box drawer. Pencil tray. 1 door. 1 shelf.</i>			
	20 x 21 x 36	500 x 520 x 900	QS41_N-MS212036	1,298
	Specify the handle code (X, Y, L).			
	<i>1 sliding shelf, 2 box drawers. Pencil tray. 2 doors. 2 shelves.</i>			
	36 x 21 x 36	900 x 520 x 900	QS41_N-MS213636	2,014
	Specify the handle code (X, Y, L).			
Right reception desks  	<i>Desk with pedestal on left, 1 box drawer and 1 file drawer with suspension bar. Lock. Pencil tray. 2 grommets. Full-height modesty panel.</i>			
	72 x 30 x 42	1800 x 750 x 1050	QS41_N-GF3072S	2,161
	<i>Full-height pedestal option.</i>			
	72 x 30 x 42	1800 x 750 x 1050	QS41_N-GUF3072S	2,362
	Specify the handle code (X, Y, N).			
	<i>Right return with pedestal on right, 1 box drawer and 1 file drawer with suspension bar. Lock. Pencil tray. 1 grommet. Full-height modesty panel.</i>			
	48 x 24 x 42	1200 x 600 x 1050	QS41_N-GR2448F	1,411
	42 x 24 x 42	1050 x 600 x 1050	QS41_N-GR2442F	1,379
	<i>Full-height pedestal option.</i>			
	48 x 24 x 42	1200 x 600 x 1050	QS41_N-GR2448UF	1,612
42 x 24 x 42	1050 x 600 x 1050	QS41_N-GR2442UF	1,579	
Specify the handle code (X, Y, N).				

 = ASSEMBLY REQUIRED

	W x D x H (in)	W x D x H (mm)	Code	Price (\$)
Left reception desks	<i>Desk with pedestal on right, 1 box drawer and 1 file drawer with suspension bar. Lock. Pencil tray. 2 grommets. Full-height modesty panel.</i>			
	72 x 30 x 42	1800 x 750 x 1050	QS41_N-GS3072F	2,161

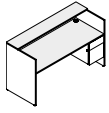

<i>Full-height pedestal option.</i>			
72 x 30 x 42	1800 x 750 x 1050	QS41_N-GS3072UF	2,362

Specify the handle code (X, Y, N).

Left return with pedestal on left, 1 box drawer and 1 file drawer with suspension bar. Lock. Pencil tray. 1 grommet. Full-height modesty panel.	<i>Left return with pedestal on left, 1 box drawer and 1 file drawer with suspension bar. Lock. Pencil tray. 1 grommet. Full-height modesty panel.</i>			
	48 x 24 x 42	1200 x 600 x 1050	QS41_N-GF2448R	1,411
	42 x 24 x 42	1050 x 600 x 1050	QS41_N-GF2442R	1,379



<i>Full-height pedestal option.</i>			
48 x 24 x 42	1200 x 600 x 1050	QS41_N-GUF2448R	1,612
42 x 24 x 42	1050 x 600 x 1050	QS41_N-GUF2442R	1,579



Specify the handle code (X, Y, N).

Additional legs	<i>1 full leg. For AT, DT and CM tables.</i>			
	30 x 1 x 27½	750 x 25 x 698	QS4NNN-L30	217
	24 x 1 x 27½	600 x 25 x 698	QS4NNN-L24	203
	20 x 1 x 27½	500 x 25 x 698	QS4NNN-L20	185



Additional leg	<i>1 recessed leg. For AT, DT and CM tables.</i>			
	13 x 1 x 27½	340 x 25 x 698	QS4NNN-L12	168



BASE OPTIONS / QUANTITY						
	Top Lengths					
		LGC-CR22	LGC-CR27	LGC-CR33	LGC-2V18	LGC-TL*
36" DEPTH	36"	1				4
	72"	2			1	4
42" DEPTH	42"		1			4
48" DEPTH	48"			1		4
	96"			2	1	4
	120"			3	1+1 CR33	6
	144"			3	1+1 CR33	6

* Not compatible with round tops.

SUGGESTIONS

41_N-PLAN01

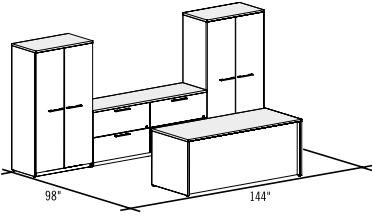

Plan shown in Concept 400E Flyer:

QS41YN-PLAN01 **\$7,776**

- 1 QS41YN-F3072S
- 1 QS41YN-LF2072LF
- 2 QS41YN-203665B

Imperia pull (Y).

41_N-PLAN09

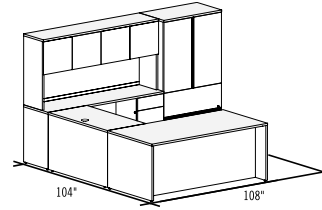

Not shown in Concept 400E Flyer:

QS41_N-PLAN09 **\$7,489**

- 1 QS41_N-F3672S
- 1 QS41NN-BR2448
- 1 QS41_N-S2072F
- 1 QS41NN-E723616P
- 1 QS41_N-203665LFB

41_N-PLAN05

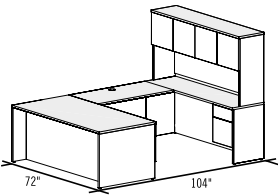

Plan shown in Concept 400E Flyer:

QSQS41LN-PLAN05 **\$5,097**

- 1 QS41LN-F3672S
- 1 QS41NN-BR2448
- 1 QS41LN-S2072F
- 1 QS41NN-E723616P

Linear pull (L).

41_N-PLAN10

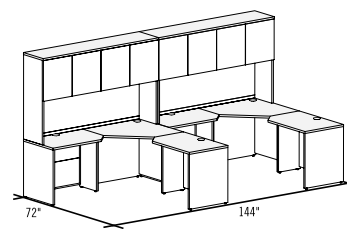

Not shown in Concept 400E Flyer:

QS41_N-PLAN10 **\$9,991**

- 2 QS41NN-CM3618S
- 2 QS41NN-AT243618B
- 2 QS41NN-AT183624B
- 2 QS41NN-E723616P
- 2 QS41_N-F

41_N-PLAN07

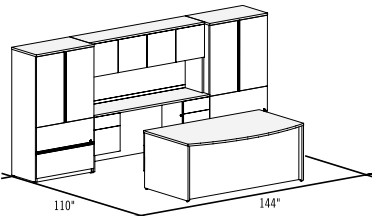

Not shown in Concept 400E Flyer:

QS41_N-PLAN07 **\$10,485**

- 1 QS41_N-F4272FA
- 1 QS41_N-F2072F
- 1 QS41NN-E723616P
- 2 QS41_N-203665LFB

41_N-PLAN11

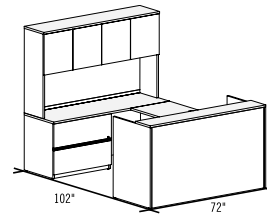

Not shown in Concept 400E Flyer:

QS41_N-PLAN11 **\$6,433**

- 1 QS41_N-GS3072F
- 1 QS41NN-BR2448
- 1 QS41_N-LF2472S
- 1 QS41NN-E724416P

41_N-PLAN08

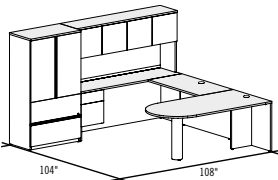

Not shown in Concept 400E Flyer:

QS41_N-PLAN08 **\$7,023**

- 1 QS41NN-BT3672
- 1 QS41NN-BR2448
- 1 QS41_N-F2072S
- 1 QS41NN-E723616P
- 1 QS41_N-203665LFB

41_N-PLAN12

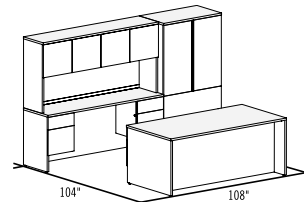

Not shown in Concept 400E Flyer:

QS41_N-PLAN12 **\$7,729**

- 1 QS41_N-F3672F
- 1 QS41_N-F2072F
- 1 QS41NN-E723616P
- 1 QS41_N-203665LFB

 = ASSEMBLY REQUIRED

SUGGESTIONS

41_N-PLAN13

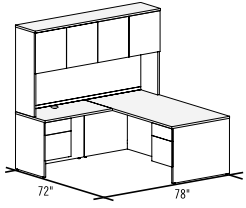

Not shown in Concept 400E Flyer:

Quantity	Part Number	Price
1	QS41_N-PLAN13	\$4,578
1	QS41_N-S3672F	
1	QS41_N-F2442R	
1	QS41NN-E784416P	

41_N-PLAN15

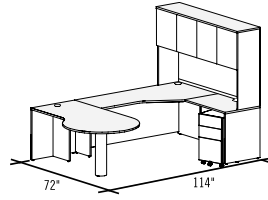

Not shown in Concept 400E Flyer:

Quantity	Part Number	Price
1	QS41_N-PLAN15	\$6,319
1	QS41NN-PT3072	
1	QS41NN-CM723624B	
1	QS41NN-DT2436B	
1	QS41NN-E724416P	
1	QS4N_N-MP1518UF	

41_N-PLAN14

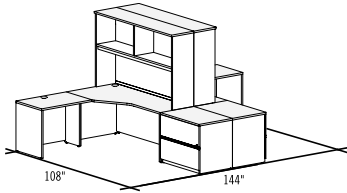

Not shown in Concept 400E Flyer:

Quantity	Part Number	Price
1	QS41_N-PLAN14	\$9,991
1	QS41NN-CM367224A	
1	QS41NN-CM723624A	
2	QS41NN-DT2436B	
2	QS41NN-E724416	
2	QS41_N-2436LF	

TYPICAL WOOD GRAIN DIRECTION FOR CONCEPT 400E:

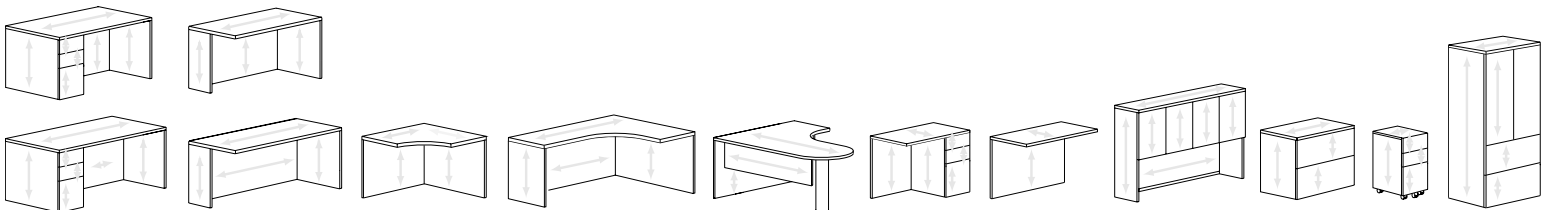

 = ASSEMBLY REQUIRED