

LACASSE QUICKSHIP PROGRAM

> CONCEPT 70

LACASSE QUICKSHIP PROGRAM*

Products and suggested layouts identified by this pictogram are part of the Lacasse quick delivery program.

* Due to current market conditions, always refer to our Lead-Time Guide for a confirmation of our current Lacasse QuickShip lead-times.

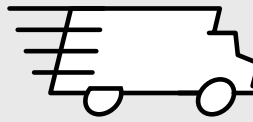

PROGRAM CONDITIONS AND LIMITATIONS:

- Maximum of 35 of each selected item and of each color per order.
- QuickShip products are ready for shipment **after reception of a ready-to-process order and delivered on next available trailer.**

IMPORTANT:

Place QuickShip orders separately from regular Lacasse orders.

When preparing QuickShip orders, indicate the code "QS" in front of the product code or the suggested layout code, i.e.: **QS71DA-F3672F**.

AVAILABLE OPTIONS AND FINISHES:

Make sure to complete QuickShip product codes with the options and finish codes that are part of the QuickShip program. See below for the complete list of QuickShip options and finishes relevant to the Concept 70 collection:

- **HANDLES**
D, K
- **ACCENT COLORS**
A, B, N



Please refer to the current LACASSE General Price Book to see all the collections and the details of the product offering.

CONCEPT 70 - QUICKSHIP PROGRAM

EDGE BANDING

1" and 1½" (25 and 38 mm) thick tops.

1½" (38 mm) thick tops.



Smooth, ¼" (1,5 mm) thick edge. The **N** edge is matched with the finish specified for the surface.

N Edge

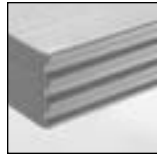

Textured 1 Edge

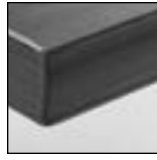

Textured 2 Edge

Textured, ⅛" (3 mm) thick edge.

The textured 1 and 2 edges are available in matching color **ONLY** when a **BUC, CCL, CER, ERH, HRG, HZN, RAS, SAH** or **TOM** is specified for the surface.

CODIFICATION

Series	Options		
	Edgebanding	Handles	Accents
7	N Smooth edge	D Straight	A Anthracite Grey
	1 Textured edge 1	K Classic	B Brass
	2 Textured edge 2		N Nickel

HANDLES

Choice of 2 metal pulls in 3 colors available.



D - Straight



K - Classic

	W x D x H (in)	W x D x H (mm)	Code	Price (\$)
	72 x 36 x 29½	1800 x 900 x 748	QS7___-F3672F	2,410
	66 x 30 x 29½	1650 x 750 x 748	QS7___-F3066F	2,257
	60 x 30 x 29½	1500 x 750 x 748	QS7___-F3060F	2,184

Specify the edge (N, 1, 2). Specify the handle code (D, K). Specify the accent color (A, B, N).

	W x D x H (in)	W x D x H (mm)	Code	Price (\$)
	72 x 42 x 29½	1800 x 1050 x 748	QS7___-F4272FA	2,739

Specify the edge (N, 1, 2). Specify the handle code (D, K). Specify the accent color (A, B, N).

	W x D x H (in)	W x D x H (mm)	Code	Price (\$)
	72 x 36 x 29½	1800 x 900 x 748	QS7___-F3672S	1,910
	66 x 30 x 29½	1650 x 750 x 748	QS7___-F3066S	1,760

Specify the edge (N, 1, 2). Specify the handle code (D, K). Specify the accent color (A, B, N).

	W x D x H (in)	W x D x H (mm)	Code	Price (\$)
	72 x 36 x 29½	1800 x 900 x 748	QS7___-S3672F	1,910
	66 x 30 x 29½	1650 x 750 x 748	QS7___-S3066F	1,760

Specify the edge (N, 1, 2). Specify the handle code (D, K). Specify the accent color (A, B, N).

	W x D x H (in)	W x D x H (mm)	Code	Price (\$)
	84 x 42 x 29½	2100 x 1050 x 748	QS7___-F4284SA	2,571
	72 x 42 x 29½	1800 x 1050 x 748	QS7___-F4272SA	2,410

Specify the edge (N, 1, 2). Specify the handle code (D, K). Specify the accent color (A, B, N).

	W x D x H (in)	W x D x H (mm)	Code	Price (\$)
	84 x 42 x 29½	2100 x 1050 x 748	QS7___-S4284FA	2,571
	72 x 42 x 29½	1800 x 1050 x 748	QS7___-S4272FA	2,410

Specify the edge (N, 1, 2). Specify the handle code (D, K). Specify the accent color (A, B, N).

	W x D x H (in)	W x D x H (mm)	Code	Price (\$)
	72 x 36 x 29½	1800 x 900 x 748	QS7___-UF3672UF	2,909
	72 x 30 x 29½	1800 x 750 x 748	QS7___-UF3072UF	2,829
	66 x 30 x 29½	1650 x 750 x 748	QS7___-UF3066UF	2,755
	60 x 30 x 29½	1500 x 750 x 748	QS7___-UF3060UF	2,683

Specify the edge (N, 1, 2). Specify the handle code (D, K). Specify the accent color (A, B, N).

	W x D x H (in)	W x D x H (mm)	Code	Price (\$)
	72 x 42 x 29½	1800 x 1050 x 748	QS7___-UF4272UFA	3,281

Specify the edge (N, 1, 2). Specify the handle code (D, K). Specify the accent color (A, B, N).

	W x D x H (in)	W x D x H (mm)	Code	Price (\$)
	72 x 36 x 29½	1800 x 900 x 748	QS7___-UF3672S	2,161
	72 x 30 x 29½	1800 x 750 x 748	QS7___-UF3072S	2,087
	66 x 30 x 29½	1650 x 750 x 748	QS7___-UF3066S	2,008
	60 x 30 x 29½	1500 x 750 x 748	QS7___-UF3060S	1,934

Specify the edge (N, 1, 2). Specify the handle code (D, K). Specify the accent color (A, B, N).

= ASSEMBLY REQUIRED

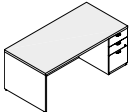
	W x D x H (in)	W x D x H (mm)	Code	Price (\$)
Right single pedestal desks – low profile 	<i>1 pedestal on right with lock, 2 box drawers and 1 file drawer with suspension bar. Pencil tray. Recessed, full-height modesty panel.</i>			
	72 x 36 x 29½	1800 x 900 x 748	QS7___-S3672UF	2,161
	72 x 30 x 29½	1800 x 750 x 748	QS7___-S3072UF	2,087
	66 x 30 x 29½	1650 x 750 x 748	QS7___-S3066UF	2,008
	60 x 30 x 29½	1500 x 750 x 748	QS7___-S3060UF	1,934

Specify the edge (N, 1, 2). Specify the handle code (D, K). Specify the accent color (A, B, N).

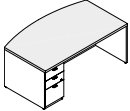
	W x D x H (in)	W x D x H (mm)	Code	Price (\$)
Left single pedestal bow front desk – low profile 	<i>1 pedestal on left with lock, 2 box drawers and 1 file drawer with suspension bar. Pencil tray. Recessed, full-height modesty panel.</i>			
	72 x 42 x 29½	1800 x 1050 x 748	QS7___-UF4272SA	2,662

Specify the edge (N, 1, 2). Specify the handle code (D, K). Specify the accent color (A, B, N).

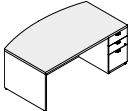
	W x D x H (in)	W x D x H (mm)	Code	Price (\$)
Right single pedestal bow front desk – low profile 	<i>1 pedestal on right with lock, 2 box drawers and 1 file drawer with suspension bar. Pencil tray. Recessed, full-height modesty panel.</i>			
	72 x 42 x 29½	1800 x 1050 x 748	QS7___-S4272UFA	2,662

Specify the edge (N, 1, 2). Specify the handle code (D, K). Specify the accent color (A, B, N).

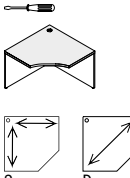
	W x D x H (in)	W x D x H (mm)	Code	Price (\$)
Corner module 	<i>Full-height modesty panel. 1 grommet. Must be attached to a work surface.</i>			
	42 x 42 x 29½	1050 x 1050 x 748	QS7_NN-CM4224S	1,317

Surface 42" / 24" R1 25 1/8" (637 mm)

Specify the edge (N, 1, 2). Diagonal wood grain: change S to D, add 10% to the price.

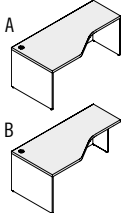
	W x D x H (in)	W x D x H (mm)	Code	Price (\$)
Right extended corner module – 24" D 	<i>Full-height modesty panel. 1 grommet.</i>			
	72 x 36 x 29½	1800 x 900 x 748	QS7_NN-CM367224_	1,597

Surface 72" / 36" R1 21 1/8" (573 mm) R2 21 1/8" (573 mm)

Specify the edge (N, 1, 2). Specify panel legs (A, B).

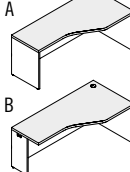
	W x D x H (in)	W x D x H (mm)	Code	Price (\$)
Left extended corner module – 24" D 	<i>Full-height modesty panel. 1 grommet.</i>			
	72 x 36 x 29½	1800 x 900 x 748	QS7_NN-CM723624_	1,597

Surface 72" / 36" R1 21 1/8" (573 mm) R2 21 1/8" (573 mm)

Specify the edge (N, 1, 2). Specify panel legs (A, B).

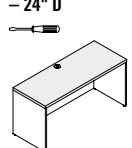
	W x D x H (in)	W x D x H (mm)	Code	Price (\$)
Rectangular tables – 24" D 	<i>Full-height modesty panel. 1 grommet.</i>			
	72 x 24 x 29½	1800 x 600 x 748	QS7_NN-DT2472_	1,166
	60 x 24 x 29½	1500 x 600 x 748	QS7_NN-DT2460_	1,076
	48 x 24 x 29½	1200 x 600 x 748	QS7_NN-DT2448_	965
	36 x 24 x 29½	900 x 600 x 748	QS7_NN-DT2436_	867

Specify the edge (N, 1, 2). Specify panel legs (A, B, C).

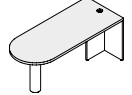
	W x D x H (in)	W x D x H (mm)	Code	Price (\$)
D-shaped work table 	<i>Steel leg: A Anthracite Grey. 1 grommet. Must be attached to a work surface.</i>			
	72 x 36 x 29½	1800 x 900 x 748	QS7_NA-BT3672	1,371

Packaged in 2 boxes.

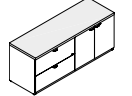
	W x D x H (in)	W x D x H (mm)	Code	Price (\$)
Lateral file / bookcase credenzas 	<i>2 file drawers with suspension bars. Bookcase unit with doors and adjustable shelf. Locks.</i>			
	72 x 24 x 29½	1800 x 600 x 748	QS7___-LF2472B	2,577
	72 x 20 x 29½	1800 x 500 x 748	QS7___-LF2072B	2,401

Specify the edge (N, 1, 2). Specify the handle code (D, K). Specify the accent color (A, B, N).

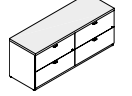
	W x D x H (in)	W x D x H (mm)	Code	Price (\$)
Lateral file credenzas 	<i>4 file drawers with suspension bars. Locks. Optional counterweights to meet BIFMA standards, refer to the Lacasse general price book.</i>			
	72 x 24 x 29½	1800 x 600 x 748	QS7___-LF2472LF	2,829
	72 x 20 x 29½	1800 x 500 x 748	QS7___-LF2072LF	2,668

Specify the edge (N, 1, 2). Specify the handle code (D, K). Specify the accent color (A, B, N).

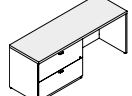
	W x D x H (in)	W x D x H (mm)	Code	Price (\$)
Left lateral file credenzas 	<i>2 file drawers on left with suspension bars. Lock. Grommet on back.</i>			
	72 x 24 x 29½	1800 x 600 x 748	QS7___-LF2472S	2,231
	72 x 20 x 29½	1800 x 500 x 748	QS7___-LF2072S	2,057

Specify the edge (N, 1, 2). Specify the handle code (D, K). Specify the accent color (A, B, N).

	W x D x H (in)	W x D x H (mm)	Code	Price (\$)
Right lateral file credenzas 	<i>2 file drawers on right with suspension bars. Lock. Grommet on back.</i>			
	72 x 24 x 29½	1800 x 600 x 748	QS7___-S2472LF	2,231
	72 x 20 x 29½	1800 x 500 x 748	QS7___-S2072LF	2,057

Specify the edge (N, 1, 2). Specify the handle code (D, K). Specify the accent color (A, B, N).

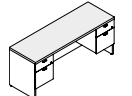
	W x D x H (in)	W x D x H (mm)	Code	Price (\$)
Double pedestal credenzas 	<i>2 pedestals with locks, 2 box drawers and 2 file drawers with suspension bars. Pencil tray. Grommet on back.</i>			
	72 x 24 x 29½	1800 x 600 x 748	QS7___-F2472F	2,106
	72 x 20 x 29½	1800 x 500 x 748	QS7___-F2072F	1,950

Specify the edge (N, 1, 2). Specify the handle code (D, K). Specify the accent color (A, B, N).

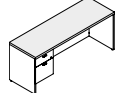
	W x D x H (in)	W x D x H (mm)	Code	Price (\$)
Left single pedestal credenzas 	<i>1 pedestal on left with lock, 1 box drawer and 1 file drawer with suspension bar. Pencil tray. Grommet on back.</i>			
	72 x 24 x 29½	1800 x 600 x 748	QS7___-F2472S	1,676
	72 x 20 x 29½	1800 x 500 x 748	QS7___-F2072S	1,640

Specify the edge (N, 1, 2). Specify the handle code (D, K). Specify the accent color (A, B, N).

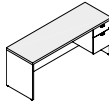
	W x D x H (in)	W x D x H (mm)	Code	Price (\$)
Right single pedestal credenzas	<i>1 pedestal on right with lock, 1 box drawer and 1 file drawer with suspension bar. Pencil tray. Grommet on back.</i>			
	72 x 24 x 29½	1800 x 600 x 748	QS7___-S2472F	1,676
	72 x 20 x 29½	1800 x 500 x 748	QS7___-S2072F	1,640
	Specify the edge (N, 1, 2). Specify the handle code (D, K). Specify the accent color (A, B, N).			

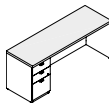
Left single pedestal credenza – low profile	<i>1 pedestal on left with lock, 2 box drawers and 1 file drawer with suspension bar. Pencil tray. Grommet on back.</i>			
	72 x 24 x 29½	1800 x 600 x 748	QS7___-UF2472S	1,934
	Specify the edge (N, 1, 2). Specify the handle code (D, K). Specify the accent color (A, B, N).			

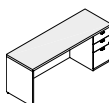
Right single pedestal credenza – low profile	<i>1 pedestal on right with lock, 2 box drawers and 1 file drawer with suspension bar. Pencil tray. Grommet on back.</i>			
	72 x 24 x 29½	1800 x 600 x 748	QS7___-S2472UF	1,934
	Specify the edge (N, 1, 2). Specify the handle code (D, K). Specify the accent color (A, B, N).			

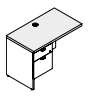
Left executive returns	<i>1 pedestal on left with lock, 1 box drawer and 1 file drawer with suspension bar. Pencil tray. Grommet.</i>			
	48 x 24 x 29½	1200 x 600 x 748	QS7___-F2448R	1,345
	42 x 24 x 29½	1050 x 600 x 748	QS7___-F2442R	1,282
	Specify the edge (N, 1, 2). Specify the handle code (D, K). Specify the accent color (A, B, N).			

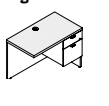
Right executive returns	<i>1 pedestal on right with lock, 1 box drawer and 1 file drawer with suspension bar. Pencil tray. Grommet.</i>			
	48 x 24 x 29½	1200 x 600 x 748	QS7___-R2448F	1,345
	42 x 24 x 29½	1050 x 600 x 748	QS7___-R2442F	1,282
	Specify the edge (N, 1, 2). Specify the handle code (D, K). Specify the accent color (A, B, N).			

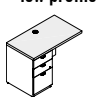
Left executive returns – low profile	<i>1 pedestal on left with lock, 2 box drawers and 1 file drawer with suspension bar. Pencil tray. Grommet.</i>			
	48 x 24 x 29½	1200 x 600 x 748	QS7___-UF2448R	1,605
	42 x 24 x 29½	1050 x 600 x 748	QS7___-UF2442R	1,530
	Specify the edge (N, 1, 2). Specify the handle code (D, K). Specify the accent color (A, B, N).			

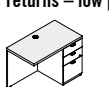
Right executive returns – low profile	<i>1 pedestal on right with lock, 2 box drawers and 1 file drawer with suspension bar. Pencil tray. Grommet.</i>			
	48 x 24 x 29½	1200 x 600 x 748	QS7___-R2448UF	1,605
	42 x 24 x 29½	1050 x 600 x 748	QS7___-R2442UF	1,530
	Specify the edge (N, 1, 2). Specify the handle code (D, K). Specify the accent color (A, B, N).			

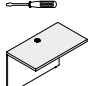
Bridge-returns	<i>Full-height modesty panel. 1 grommet.</i>			
	48 x 24 x 29½	1200 x 600 x 748	QS7_NN-BR2448	620
	42 x 24 x 29½	1050 x 600 x 748	QS7_NN-BR2442	580
	Specify the edge (N, 1, 2).			

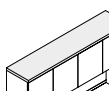
Hutches with doors – 44" H	<i>Clearance: 21¼". 4 doors. Grommet. Full-width wire access. Can accommodate a tackboard, refer to the Lacasse general price book.</i>			
	78 x 16 x 44	1950 x 400 x 1099	QS7_NN-E784416P	2,029
	72 x 16 x 44	1800 x 400 x 1099	QS7_NN-E724416P	1,950
	Specify the edge (N, 1, 2).			

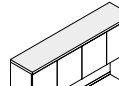
	W x D x H (in)	W x D x H (mm)	Code	Price (\$)
Hutches with doors – 36" H	<i>Clearance: 17¾". 4 doors. Grommet. Full-width wire access. Can accommodate a tackboard, refer to the Lacasse general price book.</i>			
	78 x 16 x 36	1950 x 400 x 900	QS7_NN-E783616P	1,869
	72 x 16 x 36	1800 x 400 x 900	QS7_NN-E723616P	1,780
	Specify the edge (N, 1, 2).			

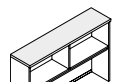
Open hutch – 44" H	<i>Clearance: 21¼". Grommet. Full-width wire access. Can accommodate a tackboard, refer to the Lacasse general price book.</i>			
	72 x 16 x 44	1800 x 400 x 1099	QS7_NN-E724416	1,621
	Specify the edge (N, 1, 2).			

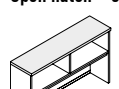
Open hutch – 36" H	<i>Clearance: 17¾". Grommet. Full-width wire access. Can accommodate a tackboard, refer to the Lacasse general price book.</i>			
	72 x 16 x 36	1800 x 400 x 900	QS7_NN-E723616	1,452
	Specify the edge (N, 1, 2).			

Lateral file units	<i>Suspension bars. Lock. Optional counterweights to meet BIFMA standards, refer to the Lacasse general price book.</i>			
	36 x 24 x 29½	900 x 600 x 748	QS7___-2436LF	1,506
	36 x 20 x 29½	900 x 500 x 748	QS7___-2036LF	1,467
	Specify the edge (N, 1, 2). Specify the handle code (D, K). Specify the accent color (A, B, N).			

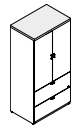
Storage units with lateral file	<i>2 adjustable shelves. 2 lateral file drawers with suspension bars. Lock on drawer. 73" H storage matches the height of a credenza with a 44" H hutch. 65" H storage unit matches the height of a credenza with a 36" H hutch.</i>			
	36 x 24 x 73½	900 x 600 x 1847	QS7___-243673LFB	2,878
	36 x 20 x 73½	900 x 500 x 1847	QS7___-203673LFB	2,706
	36 x 20 x 65½	900 x 500 x 1648	QS7___-203665LFB	2,604
	Specify the edge (N, 1, 2). Specify the handle code (D, K). Specify the accent color (A, B, N).			

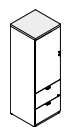



Storage units with lateral file	<i>Reversible door. 2 adjustable shelves. 2 lateral file drawers with suspension bars. Lock. 73" H storage unit matches the height of a credenza with a 44" H hutch. 65" H storage unit matches the height of a credenza with a 36" H hutch.</i>			
	24 x 20 x 73½	600 x 500 x 1847	QS7___-202473FB	2,231
	24 x 20 x 65½	600 x 500 x 1648	QS7___-202465FB	2,135
	Specify the edge (N, 1, 2). Specify the handle code (D, K). Specify the accent color (A, B, N).			





Open bookcases	<i>4 adjustable shelves.</i>			
	36 x 14 x 73½	900 x 350 x 1847	QS7_NN-B367314	1,335
	36 x 14 x 65½	900 x 350 x 1648	QS7_NN-B366514	1,256
	Specify the edge (N, 1, 2).			

	<i>2 adjustable shelves.</i>			
	36 x 14 x 48½	900 x 350 x 1226	QS7_NN-B364814	1,119
	Specify the edge (N, 1, 2).			

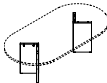
	<i>Additional shelf.</i>			
	34 x 13 x 1	846 x 325 x 25	QS7NNN-TB3614.1E	168

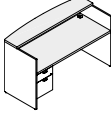
Mobile pedestals	<i>2 box drawers, 1 file drawer with suspension bar. Pencil tray. Brakes on front casters. Lock. Fits under a work surface. 1 tone only.</i>			
	15 x 23 x 27½	390 x 575 x 689	QS7N_-MP1523UF	1,219
	15 x 18 x 27½	390 x 450 x 689	QS7N_-MP1518UF	1,138
	Specify the handle code (D, K). Specify the accent color (A, B, N).			

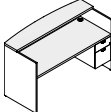
	W x D x H (in)	W x D x H (mm)	Code	Price (\$)
Mobile pedestal 	<i>2 file drawers with suspension bars. Brakes on front casters. Lock. Fits under a work surface. 1 tone only.</i>			
	15 x 23 x 27½	390 x 575 x 689	QS7N__-MP1523FF	1,161
	Specify the handle code (D, K). Specify the accent color (A, B, N).			
Hanging pedestal 	<i>1 box drawer and 1 file drawer with suspension bar. Pencil tray. Lock. Must be installed under a work surface. 1 tone only.</i>			
	15 x 17½ x 19¼	388 x 448 x 489	QS7N__-F	926
	Specify the handle code (D, K). Specify the accent color (A, B, N).			
Round top 	<i>Conference table.</i>			
	42 x 42 x 1½	1050 x 1050 x 38	QS7_NN-R42	731
	Specify the edge (N, 1, 2).			
Racetrack tops 	<i>Conference tables. 120" and 144" tops are in two pieces.</i>			
	72 x 36 x 1½	1800 x 900 x 38	QS7_NN-RT72	1,047
	96 x 48 x 1½	2400 x 1200 x 38	QS7_NN-RT96	1,419
	144 x 48 x 1½	3600 x 1200 x 38	QS7_NN-RT144	1,854
144" to 120": Packaged in 2 boxes.	Specify the edge (N, 1, 2).			
Cross base 	<i>1½" thermofused laminate.</i>			
	27 x 27 x 28	680 x 680 x 710	QSLGC-CR27	590
V-base 	<i>1½" thermofused laminate.</i>			
	18 x 18 x 28	450 x 450 x 710	QSLGC-2V18	(pair) 849

	W x D x H (in)	W x D x H (mm)	Code	Price (\$)
Right reception desks 	<i>Desk with pedestal on left, 1 box drawer and 1 file drawer with suspension bar. Lock. Pencil tray. 2 grommets. Full-height modesty panel. Bow shaped transaction shelf.</i>			
	72 x 30 x 42½	1800 x 750 x 1075	QS7___-GF3072S	2,371
	Specify the edge (N, 1, 2). Specify the handle code (D, K). Specify the accent color (A, B, N).			
	<i>Right returns with pedestal on right, 1 box drawer and 1 file drawer with suspension bar. Lock. Pencil tray. 1 grommet. Full-height modesty panel.</i>			
	42 x 24 x 41	1050 x 600 x 1037	QS7___-GR2442F	1,557
	Specify the edge (N, 1, 2). Specify the handle code (D, K). Specify the accent color (A, B, N).			
Left reception desks 	<i>Desk with pedestal on right, 1 box drawer and 1 file drawer with suspension bar. Lock. Pencil tray. 2 grommets. Full-height modesty panel. Bow shaped transaction shelf.</i>			
	72 x 30 x 42½	1800 x 750 x 1075	QS7___-GS3072F	2,371
	Specify the edge (N, 1, 2). Specify the handle code (D, K). Specify the accent color (A, B, N).			
	<i>Left returns with pedestal on left, 1 box drawer and 1 file drawer with suspension bar. Lock. Pencil tray. 1 grommet. Full-height modesty panel.</i>			
	42 x 24 x 41	1050 x 600 x 1037	QS7___-GF2442R	1,557
	Specify the edge (N, 1, 2). Specify the handle code (D, K). Specify the accent color (A, B, N).			

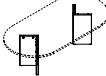
BASE OPTIONS / QUANTITY			
	Top Lengths	 LGC-CR27	 LGC-2V18
36" DEPTH	72"		1
42" DEPTH	42"	1	
48" DEPTH	96"		1
	120"		
	144"		1+1 CR33

 = ASSEMBLY REQUIRED

SUGGESTIONS

7 ___-PLAN02

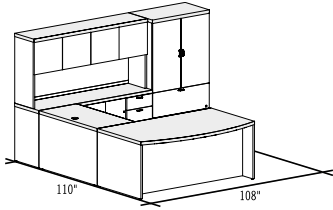

Plan shown in Concept 70 Flyer:

QS72DN-PLAN02 \$9,059

- 1 QS72DN-F4272SA
- 1 QS72NN-BR2448
- 1 QS72DN-S2072F
- 1 QS72NN-E723616P
- 1 QS72DN-203665LFB

Textured edge (2), straight pull (D) in Nickel (N).

7 ___-PLAN10

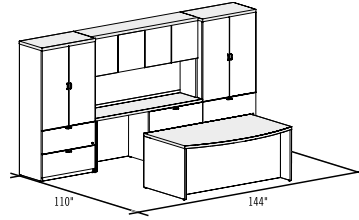

Not shown in Concept 70 Flyer:

QS7 ___-PLAN10 \$11,833

- 1 QS7 ___-F4272SA
- 1 QS7 ___-S2072LF
- 1 QS7 _NN-E724416P
- 2 QS7 ___-203673LFB

7 ___-PLAN07

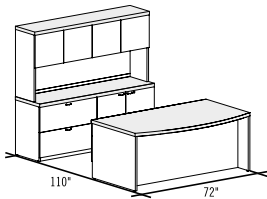

Not shown in Concept 70 Flyer:

QS7 ___-PLAN07 \$6,923

- 1 QS41LN-F3672S
- 1 QS41NN-BR2448
- 1 QS41NN-E723616P

7 ___-PLAN11

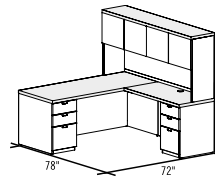

Not shown in Concept 70 Flyer:

QS7 ___-PLAN11 \$5,561

- 1 QS7 ___-UF3072S
- 1 QS7 ___-R2448UF
- 1 QS7 _NN-E783616P

7 ___-PLAN09

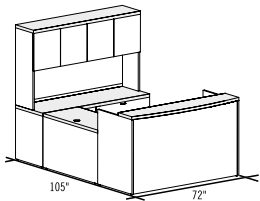

Not shown in Concept 70 Flyer:

QS7 ___-PLAN09 \$7,173

- 1 QS7 ___-GF3072S
- 1 QS7 _NN-BR2448
- 1 QS7 ___-S2472LF
- 1 QS7 _NN-E724416P

7 ___-PLAN12

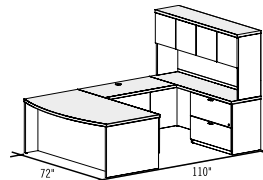

Not shown in Concept 70 Flyer:

QS7 ___-PLAN12 \$6,868

- 1 QS7 ___-F4272SA
- 1 QS7 _NN-BR2448
- 1 QS7 ___-S2072LF
- 1 QS7 _NN-E723616P

TYPICAL WOOD GRAIN DIRECTION FOR CONCEPT 70:

